

NAVAL AVIATION

# NEWS



Flying Pinwheels  
Jet Power Boost  
News Visits NARTU

SEPT. 1947

SHARE  
THIS  
COPY



**DOWN SOUTH, SUH** There is lots of water in these two pictures, both of them below the Mason-Dixon line, so boat pilots should feel at home. Would you know where you were? Check yourself on last page.



# Flying Pinwheels



**W**ALKING down a lonely Long Island beach, a fisherman was startled recently when he came across an odd-looking contraption. It was a fuselage on wheels with a big fan on top and a smaller fan at the rear end.

"How the devil did you get that thing in here?" he asked the young Navy lieutenant standing nearby. "Drive it in or pull it?"

He was even more astounded when, several hours later, the queer looking contraption rose straight up in the air, hung stationary while the pilot saluted and then nonchalantly flew away like a huge flying spider.

However, he was not nearly so impressed as the young pilot who ditched a *Helldiver* during recent Atlantic Fleet maneuvers. Only seconds after his plane had sunk and he was resigning himself to the same fate, a Sikorsky helicopter pilot dropped a line into his hands and hoisted him aboard. And thereby a helicopter saved a life that otherwise surely would have been lost.



CAPTAIN C. C. MARCY USN

In little over a year since the Navy's first helicopter squadron was formed, this new type aircraft has gained an important and respected position in the Fleet. And the helicopter's versatility is only now becoming apparent to Naval Aviation.

Fleet Commanders, during recent maneuvers and varied expeditions to all parts of the world have been both pleased and surprised to find that a helicopter can land on the gun turret of a rolling and pitching ship or hover above a submarine; and even without instruments they fly in weather that grounds combat planes.

Their utilization with all types of fleet organizations is limited today only by the time needed for developing helicopters suited to naval operations and the development of a program for training personnel. And that development is going ahead full steam at NAS LAKEHURST under the direction of Helicopter Development Squadron THREE (vx-3), Navy's only all-helicopter squadron.



HELICOPTER LINE AT NAS WAKEHURST PRESENTS STRANGE APPEARANCE TO NAVAL AVIATORS UNUSED TO WINGLESS LARGE-PROPELLERED CRAFT

## VX-3 WORKING HARD TO FIND BEST USES FOR HELICOPTERS

DAILY operations around the squadron's big hangar are a constant reminder of the helicopter's main stocks in trade—vertical ascent and descent and stationary or hovering flight plus three-dimensional maneuverability. VX-3's operations exploit these characteristics for the Navy.

Under the command of Captain C. C. Marcy, USN, a pioneer in the Navy's rotary wing program, VX-3 bridges the gap between BUAEF experimental programs and the successful service operation of helicopters.

This squadron provides the necessary operational background to BUAEF for determining the desirable characteristics and configurations of the machines to be developed from experimental types now under construction.

VX-3 is under the operational control of Commander Operational Development Force, U.S. Fleet (See NANews August, 1947.) and Commander Air Force, Atlantic Fleet for administrative purposes.

The mission of this new experimental helicopter squadron covers a wide field. The squadron is developing and evaluating, operationally, the use of helicopters for search and rescue, as replacements for VO seaplanes, for ship-to-ship and ship-to-shore liaison, harbor traffic control, utility duties, amphibious warfare and many other useful missions which become apparent during daily test flying.

Perhaps the most publicized of the Navy helicopter's missions has been search and rescue work during carrier operations with the S-51 designated HO3S by the Navy.

### MECHS FIND PRECISION IS REQUIRED IN MAINTENANCE OF HELICOPTERS



A recent design competition has indicated that helicopters comparing favorably in performance and capable of carrying out all the functions of present VO aircraft are now feasible. However, helicopters fall somewhat short of the endurance performance of present day VO seaplanes.

Helicopters on fleet duty have already proved themselves in liaison work. There is no longer a need for the destroyers which have had to maneuver alongside ships of a task force at sea in order to deliver mail, photographs or personnel.

USE of a helicopter in this operation cancels the danger to ships and personnel. A single rotary-winged aircraft equipped with a hoist can carry out the same mission in a fraction of the time, landing only on the parent ship.

Another field for the Navy's new helicopters is ship-to-ship and ship-to-shore transportation of equipment, mail and personnel at fleet anchorages and at beachheads in amphibious warfare where boating is difficult and slow.

The helicopter's utility duties are increased because of its ability to hover or fly at speeds below that of conventional aircraft. It has already been used for observing torpedo runs, special tests and for radar calibration.

Numerous requests from activities requiring specialized utility services are already on file awaiting the availability of suitable helicopters and trained personnel.

Prior to the commissioning of VX-3, the development, evaluation and application of rotary wing aircraft was, so far as the Navy was concerned, practically non-existent. During the war, BUAEF could not afford to divert engineering effort and manpower for the development of helicopters.

The only efforts along this line were two experimental projects undertaken by the Coast Guard, then a part of the Navy. In 1943, through the enthusiastic efforts of Comdr. Frank Erickson, USCG, a helicopter program was established at CGAS FLOYD BENNETT. This unit trained pilots and carried out search and rescue, mercy and transportation missions.

Upon the return of the Coast Guard to the jurisdiction of the Treasury Department, the Navy decided to set up its own program.

Through the efforts of Captain Marcy, a task unit was hurriedly organized to accompany the naval unit in Operations *Crossroads*. This was the first organized all-Navy unit to attempt full-scale shipboard operations employing the helicopter. (NANews September, 1946.)

While the original unit was operating at sea, the first naval helicopter squadron, VX-3, was being formed at NAS FLOYD BENNETT under Comdr. C. E. Houston, USN, one of the first helicopter pilots. This was on 1 July, 1946.

A fleet of HNS-1's and seven HOS-1 Sikorsky helicopters were transferred from the Coast Guard which also helped train pilots and maintenance personnel at the beginning.

Experienced naval aviators are the only ones so far to undergo training in helicopters. Approximately five hours of instruction are needed before the average fixed-wing pilot can solo. The present syllabus is completed in 40 hours, but pilots are not considered qualified for operational duty unless they have a total of 100 hours with 30 hours in type.

Because of logistic and personnel problems VX-3 was moved to NAS LAKEHURST in September of 1946. Captain Marcy relieved Commander Houston soon after returning from the atomic bomb tests.

To date, VX-3 has trained 18 pilots. This is not an impressive number until the reader considers that the unit began operations with two qualified pilots. Numerous operations—Bikini, Operation *Highjump*, Arctic expeditions and fleet maneuvers have all taken experienced pilots to sea.

Radar calibration hops, for which the helicopter is ably suited because of its hovering abilities, sometimes boost a pilot's time to over seven hours in one day.

Observations of VX-3's daily operations leaves even an experienced Naval aviator gasping with surprise. A squadron test pilot can sometimes be seen conducting an hour-long test hop without ever leaving the parking area or getting more than a few feet off the ground.

No other aircraft is capable of hovering just above the ground after take-off so that the pilot can check his engine and controls before proceeding with the flight.

**L**ANDINGS are no problem with or without power, as the aircraft's speed can be lowered to zero just before contact with the deck is made. Engine failure does not worry experienced pilots so long as they can find a spot some 50 feet in diameter in which to land.

When an engine fails, the pilot puts his rotors into autorotation, or free-wheeling, and glides down at 50 mph at slightly less vertical speed than is reached by a descending parachute. Just before contact with the deck, the pilot feathers out, increases the pitch of his main rotors and sets down in a normal landing at zero airspeed.

The cockpits of VX-3's helicopters look much the same as those of conventional fixed-wing planes. There are the usual stick, rudders and throttle. The only additional control is the pitch stick.

This lever controls pitch or angle of attack of the main rotor blades and is used for ascent, descent and hovering. The throttle is mounted on the pitch stick and the two are partially synchronized by a governor for constant rpm.

Turns are made in the conventional manner, or with stick and rudder. But this is where normal pilots get mixed up. The "stick," as they know it, is used not only for banking, but for directional control as well. In other words, if a pilot does not want to bank, he flies sideways.

If a pilot wants to go forward, backward or sideways, he pushes the stick in that direction and moves away. This can be used to advantage in forced landings. In case of engine failure after a pilot passes a suitable spot, he can pull back on his stick, establish a backward glide, feather out and land at zero airspeed.

Since the rotor which propels and supports the helicopter is an airfoil, these rotary-winged craft can perform many maneuvers used by fixed-wing aircraft such as running take-offs and landings and balanced turns. They use the same type of approaches as conventional planes as best



PRE-FLIGHT CHECK IS MUCH THE SAME AS ON CONVENTIONAL AIRCRAFT

results are normally obtained by making all landings and take-offs into the wind.

One of the impressive features of the helicopter is its ability to fly in any direction. When a pilot has to get out of a tight spot, he can get out sideways or straight up. And, something that can not be done with a conventional plane, a helicopter can make a backward take-off. These features make them ideally suited for shipboard operation.

USUAL NEEDLE-BALL AND ARTIFICIAL HORIZON IS MISSING FROM PANEL





## PILOTS FIND THE HELICOPTER DIFFERENT BUT NOT TOO HARD

**C**ONTRARY to rumor, helicopters now have less vibration than most operational fixed-wing aircraft. Speech between passengers is almost normal.

Instrument flight is limited as no instruments have yet been adapted which will indicate the new flight dimensions peculiar to a helicopter. Since the operator sits in the nose, there is little reference for horizontal flight and he must check his altimeter continually. A position indicator is now being developed to show up, down, fore and aft flight.

Taxiing is simple and there is no need for brakes. The main rotor is tilted forward by means of the stick between the pilot's legs and pulls the craft along the deck. Leaving the line takes a minimum of time as only about 10 feet clearance is needed for a safe take-off.

Rudders control the pitch of the anti-torque rotor blades. This rotor can turn the 'copter on a dime, whether on the ground or in the air. Contrary to popular conception, this rotor does not speed up and slow down, but changes pitch.

Loss of the anti-torque rotor is not considered too dangerous by VX-3's pilots. Lieut. Jim Lamm's HOS-1 recently lost a tail rotor at 100 feet altitude and spiraled down to a safe landing.

Chief Aviation Pilot Kembro, the Navy's only enlisted helicopter pilot, recently lost a blade from the main rotor of his helicopter. This is the worst thing that can happen as the vibration makes a pilot helpless and unable to regain control. Fortunately, Kembro was only 10 feet off the deck. By hitting the stick and dumping the other two main rotor blades into the ground, he got down in one piece.

This same tactic is used for ditching a helicopter. The HOS-1 which went into Bikini lagoon lost an engine at 400 ft. The pilot auto-rotated down, slowed airspeed to zero while his passenger jumped into the water and then dumped the rotor into the drink on the pilot's side. This kept the rotor from whirling as the plane sank and trapping the pilot under water or conking him when he emerged.

**B**ECAUSE of the helicopter's early stage of development, spare parts are not too plentiful, making maintenance difficult at times. Although VX-3 had to start from scratch, its maintenance personnel have become highly skilled and the squadron's availability is as good or better than in many conventional squadrons.

Chief Machinist Haight believes that helicopter personnel must be highly skilled. Besides the conventional aircraft parts, the helicopter has a transmission and a gear box for each of the rotors. The entire machine is put together with the precision of a well-made watch.



- 1** S-51 Sikorsky helicopter landing on No. 1 turret of the U.S.S. *Missouri* under way during recent fleet maneuvers.
- 2** **Hovering** helicopter here demonstrates the technique used to pick up a downed Airman in an air-sea rescue.
- 3** **Simulated** landings aboard are being practised on this unique rolling platform located at NAS Floyd Bennett.
- 4** **Helicopter** equipped with floats is truly amphibious aircraft and can land aboard or on water with equal ease.

On the other hand, there are no problems of damage to landing gear or structure. Even if a helicopter should lose its landing gear, it could probably set down undamaged.

Several types of helicopters are being used for training as VX-3 waits for more advanced models of helicopters. Primary trainer is the Bell HTL-1, a light helicopter with a two-bladed main rotor, and cruises at 90 mph.

So stable that it will fly hands off, this helicopter speeds training because of its dual control system. It is powered by a Franklin opposed six-cylinder, 178-hp. engine.

The Sikorsky HO3S-1 is much bigger, carrying four passengers, and is powered by a 450 hp. Pratt & Whitney engine. Its three-bladed, fabric-covered main rotor has a diameter of 48 feet. Electrically controlled fore and aft tabs make it easy to trim. Flying at 103 mph, this helicopter can get to the scene of a crash in a hurry. The Navy has ordered 20 more of this type.

Still operating are a few of the first helicopters acquired by the Navy, the HNS-1's. Cruising at 70 mph, this helicopter has a 190-hp. engine and hoisting gear.

**T**HE HOS-1, used at Bikini, is also used by VX-3 for instruction. This Sikorsky helicopter will fly at 85 mph, and is powered by a 225-hp. opposed six-cylinder Franklin.

One HO3S-1 and one HTL are now on the *Randolph* for the midshipman cruise. HO3S's were also used for the Antarctic expedition carrying out photographic and ice-pack scouting missions.

Members of VX-3 are eagerly awaiting delivery of the new Piasecki XHRP-1. An all-Navy design, this helicopter will be specially adapted to shipboard work and will boast a hatch through which passengers, survivors or freight can be hauled directly into the cabin.

VX-3's small group includes, besides those mentioned previously, Comdr. M. Peters, executive officer, Major A. H. Delalio, USMC, and Lieut. C. J. Reeves, the latter two now being on the midshipman cruise aboard the *Randolph*, and Lt. Comdr. H. M. Kosciusko.

Lt. Comdrs. C. Fink, C. Tanner and Jungans flew helicopters in the Antarctic soon after qualifying at NAS LAKEHURST. Others include Lieuts. Jim Lamm, G. A. Rullo—who flew aboard the *Roosevelt* on her Caribbean cruise—E. Kubicki, Lt. (jg) W. Schaffer, Chief Machinist Haight and one student, Lt. (jg) Hamilton.

Within the next few years, every aircraft carrier may boast at least one helicopter for special missions. Operational development as now carried on by Helicopter Development Squadron Three will be expanded and accelerated as improved helicopters become available.

In the long range future, according to Captain Marcy, the naval helicopter will probably never become, primarily, a military or naval weapon. It will probably remain a vehicle of transportation and observation which will find many uses for the Navy, although the uses will be determined by this fundamental non-military characteristic.



**5 Pilots** give their helicopter its pre-flight check off of the deck in the air but before leaving the flight parking area.

**6 When** a pilot wants to make a landing with S-51 Sikorsky he just picks his spot and comes straight down into it.

**7 Flight** attitudes are somewhat different in the 'copter—this HTL is getting up its forward speed for cruising.

**8 This** HTL isn't about to stall in from fifty feet but is merely making a quick stop for a vertical no-roll landing.

# GRAMP AW PETTIBONE

## Don't Kill Your Friends

Seven enlisted men were assembled on the hangar deck of the *USS Bon Homme Richard* waiting their turn at punching the bag when an unseen adversary in the form of a high explosive 20 mm. projectile crashed through the flight deck and sent all seven to the sick bay.

The shell came from the starboard 20 mm. gun on an F6F-5N which had landed a few minutes before. The pilot reported that three of his six guns had failed to fire and he believed that he had safetied all guns. Actually he had turned the gun charging handle to "Safe" and pushed the handle down, but he had not held it down long enough to safety the guns. The 20 mm. guns were held only by the sear.

An ordnanceman finished cleaning the .50 caliber guns on the port wing and was checking the port 20 mm. gun which had failed to fire. Another ordnanceman was busy checking the starboard 20 mm. gun which had fired.

The accident occurred when the ordnanceman working on the port guns called to a "passer-by" and asked him to "let the port guns go home" (i.e. allow the gun bolts to move into the forward position). The passer-by obligingly leaned into the cockpit, turned the port gun charger to "arm," turned on the master armament switch and the inboard gun switches and pressed the pickle. The 20 mm. guns slammed home and the starboard gun fired.

Neither the port ordnanceman or the "passer-by" had checked to see what was happening to the starboard guns. With the wings folded neither could see the other ordnanceman who was working on the starboard side, but had not yet unloaded the starboard 20 mm. gun.

The accident resulted from gross violations of safety orders and a lack of plain every-day common sense in handling weapons which are designed to kill.

## Bad Risk

The *Corsair* pictured here came out of a major overhaul a few weeks ago and is headed right back for another overhaul after just 11 hours in the air. Despite its peaceful appearance, it has



a center wing panel that is sprung and distorted, an engine that needs a major overhaul, and landing gear, flaps, and propeller that must be replaced.

It was last flown by a pilot who didn't heed regulations regarding the ferrying of naval aircraft. He continued a CFR flight into instrument weather, and was forced to climb out on top in order to avoid mountains in the area. Shortly after breaking out on top of the overcast, he experienced a partial engine failure, but was fortunate enough to get down through a break in the overcast and make a successful landing at an airfield nearby.

Instead of finding out what had caused the earlier engine trouble, the pilot gave the plane a ground run-up which appeared satisfactory, and took off again. On this second leg of his flight he flew through some scattered rain storms, and again found his engine cutting out just as he broke into clear weather. The engine would not supply sufficient power to maintain altitude, and it finally quit cold about 100 feet above the terrain. A successful wheels-up, flaps down, full stall, forced landing was made in a plowed field.

Subsequent investigation disclosed that there was no Dow Corning Number 4 on the terminals of the spark plug leads as directed in Engineering Bulletin 21-43. This condition permitted the terminals to collect moisture from the clouds and showers, thereby causing the engine to cut out.

*Grampaw Pettibone Says:*

Son, your life insurance company has a bad risk on its hands. First of all you violated written orders when you continued your ferry flight into instrument weather. Then when you got a reprieve after that first engine failure, did you call it a day and wait for the experts to find out WHY the engine cut out? Oh, no—you just barged right out and asked for trouble. I don't blame your Guardian Angel for going on strike after that boner.

## "Dear Grampaw Pettibone:

Out our way we started a little discussion which has now resulted in a terrific argument. In order to settle things we call on you to give your opinion on this problem.

1. Who is in charge of an aircraft in flight and responsible for an accident if one occurs:

a. Is it the Senior Aviator present? Why?

b. Is it the Senior Naval Aviator at the controls of the aircraft? Any light thrown our way may prevent further argument, but I doubt it.

Very respectfully,

MAJOR USMC



*Grampaw Pettibone Says:*

I'm glad you asked this question and I'm not surprised that it has caused some hot arguments. BuAer Manual states that any Navy plane taken into the air shall be commanded by a naval aviator, or naval aviation pilot designated by the commanding officer of the unit to which the aircraft is attached. Other naval aviators or naval aviation pilots and personnel on board the aircraft, whether or not senior to the person designated by the commanding officer, will be either in the status of the aircraft's crew or of passengers, and this status shall be clearly understood prior to the flight.

Here's the clincher: Art. 6-104—"The authority and responsibility of such commanding officer of an aircraft exist from the time he enters it preparatory to flight until he leaves it upon the completion of the flight, during which period the responsibility for the action of such aircraft and its crew and for any occurrence that results from the actions of the aircraft and its crew shall rest entirely upon him".

I think the above covers about 99% of the cases, but there are of course occasional instances where some common sense must be used in applying the rules. For example, in the case of two equally qualified pilots assigned a multi-engine plane for a two-hour bounce drill, where it is understood and authorized that each will practice landings and take-offs, a landing accident would be charged against the pilot controlling the aircraft at the time of the accident, even though the other pilot might have signed the clearance form for the flight, might be senior in rank, and riding in the co-pilot's seat.

Normally in the case of instructors and students, the instructor is clearly responsible for the safety of the flight . . . but what of the cadet who gets excited while taxiing in from a flight and jams on the brakes and stands an N2S on its nose. If



the error is clearly the cadet's and there was no corrective action that the instructor could have taken which would have prevented the accident, the accident is noted on the cards of both cadet and instructor and the pilot error is assigned to the cadet.

The important thing to remember is that when you sign the clearance form for a flight, or find your name on the daily flight schedule as pilot of a particular flight—you've got it, son, and you had better think twice before you get very far away from the controls—particularly on take-off and landing.

## Report Accidents Promptly

An accurately reported accident is a step towards a prevented accident. Time lag in accident reporting means deaths that could be avoided. Report all accidents promptly following the instructions outlined in Aircraft Circular Letter 119-45, and save lives.

## Fatal Mistake

The leader of a four plane division of SB2C's arrived at an outlying field and broke up his formation preparatory to a routine period of field carrier landing practice. Breaking off at an altitude of about 600 feet, parallel to the landing runway, the leader made a steep left turn with little or no power on. During this turn he lost altitude to commence his field carrier landing approach.

Upon nearing the approach altitude of about 100 feet the aircraft was still in a steep left turn and settling in a nose high attitude. Power was not re-applied and the plane spun to the left with about 120 degrees of the approach left to make. The plane hit the ground on the left wing and nose with a violent impact. The pilot was killed and the aircraft was demolished by impact and fire.



### Grampaw Pettibone Says:

This is only one of nine fatal spin and stall accidents in the SB2C during the past nine months. It is unique only in that the pilot who was killed in this accident had "read and initialed" Flight Safety Bulletin No. 21-44 shortly before the flight. This bulletin explains the increase of stalling speed in turns and associated dangers at low altitudes.

I'm afraid that you fellows sometimes initial safety bulletins and other important items on the "All Pilots" board without actually reading and digesting the material. It is hard to believe that this pilot really read and understood this Flight Safety Bulletin on the danger of steep low altitude turns, or paid close attention to the briefing which was given just before this flight. He violated almost every instruction that was given to him and lost his life as a result.

Keep sufficient airspeed in turns. If you get in a bad spot during a carrier or field carrier landing approach, don't be ashamed to take an early voluntary wave-off. Go around again—you'll live longer that way.

By the way, any squadron that is qualifying pilots in carrier landings or doing F.C.L.P. should arrange frequent showings of the excellent training film "Technique for Carrier Landings and Take-offs." This film may be ordered through the nearest Aviation Training Film Library and the order number is MN-5090.



## Lieutenant M. T. Head

An F4U pilot arrived at Los Angeles just before dark and circled the field calling for landing instructions. Receiving no answer, he attempted a landing without clearance from the tower and without field lighting. He selected a runway that was 5800 feet long, but over-shot and ran off the end of the runway where he hit a drainage ditch bordering the field. All blades on the propeller were bent forward a distance of twelve inches and the flaps and fairing were damaged.

The pilot had filed a clearance for another field but elected to continue on to Los Alamitos without refiling his clearance. NAS LOS ALAMITOS had no word of his expected arrival. Their airfield is closed from 1630 to 0800 unless prior notification is received of an expected flight.

**Bureau Comment**—Most pilot error accidents are caused by errors of technique, judgment, or just plain carelessness, but this one involves all three—plus disobedience of regulations.

Just to replace the three bent propeller blades on this F4U will cost close to \$2500. If inspection of the engine indicates possible damage due to sudden stoppage, it will cost an additional \$7000 for a major engine overhaul.

This accident would not have occurred if the pilot had used a little common sense and adhered to his flight clearance. He has

been ordered to appear before an informal board of investigation as a result of this accident.

## Close Out Flight Plans

**Case No. 1.** Pilot cleared for Asheville, N. C. from NAS ANACOSTIA. His clearance called for him to report his arrival at Asheville to the C.A.A. communications station at Spartanburg, as no facilities were available at Asheville for handling arrival and departure reports. Pilot violated C.A.R. 60.109 by failing to report his arrival to any C.A.A. communication station.

**Case No. 2** R4D pilot departed El Toro for Douglas, Arizona . . . failed to close out flight plan at Douglas and did not file a flight plan for the return trip. Pilot has been placed in probationary status by his commanding officer.

**Comment:** Both of these cases resulted in a great deal of unnecessary confusion, and plenty of embarrassment for the pilots concerned. Navy planes on cross-country flights are required to obtain proper clearances. When departing from a field where no communications facilities are available pilots may proceed only under contact flight rules and where practicable should fly to the nearest base or station where proper clearance may be obtained. Where this involves interference with the mission of the flight, radio clearance should be obtained from the nearest Navy clearance authority or A.A.F. Base Operations Office. After completing the flight it is the pilot's responsibility to see that his flight plan is properly closed out, so that search and rescue facilities will not be alerted on a false alarm.

Read Aviation Circular Letter 148-45 for complete details.

## Belly Landing Box Score

Here's the tally for last month on wheels up landings, an accident type that really runs up Grampaw's blood pressure:

No attempt to lower wheels	2
Inadequate attempt to lower wheels	4
Raised wheels instead of flaps	2
Improper Maintenance (Plane Captain forgot cap on hydraulic reservoir)	1
Miscellaneous material failures	5
<b>Total</b>	<b>14</b>



Here Lie the Bones  
Of Ensign Rube  
Who Forgot the Cover  
On the Pitot Tube.

# DID YOU KNOW?

## NAVY RETAINS AVIATION ARM UNDER MERGER

THE ROLE of Naval Aviation in the new Army-Navy merger set-up will be clarified as provisions of the law passed by Congress in its closing hours are put into effect by the Department of National Security headed by James Forrestal.

The law itself sets up general principles under which the Navy will continue to have a strong air arm. "The United States Navy shall include naval combat and service forces and such aviation as may be organic therein," it states.

"Naval Aviation shall consist of combat and service and training forces, and shall include land-based Naval Aviation, air transport essential for Naval operations, all air weapons and air techniques involved in the operations and activities of the United States Navy, and the entire remainder of the Aeronautical Organization

of the United States Navy, together with the personnel necessary therefor.

"The Navy shall be generally responsible for Naval reconnaissance, antisubmarine warfare, and protection of shipping. The Navy shall develop aircraft, weapons, tactics, technique, organization and equipment of Naval combat and service elements."

As for Marine aviation, the law states: "The United States Marine Corps shall include land combat and service forces and such aviation as may be organic therein. It shall be organized, trained and equipped to provide Fleet Marine Forces of combined arms, together with supporting air components, for service with the fleet in seizure and defense of advanced Naval bases . . . It shall develop in coordination with the Army and the Air Force, those phases of amphibious operations which pertain to the tactics, technique, and equipment employed by landing forces."

### New Personnel Welcomed Indoctrination Course Aids Newcomer

NAS SAN DIEGO—A one week's indoctrination course has been established at this station to pass the word to officers and men reporting for duty here.

In general, the officers' course includes a tour of the station to acquaint them with the most important of the hundreds of buildings and 1400 acres of ground. The curriculum includes instruction by designated department officers and familiarization with the duties of the Officer-of-the-Day and the watch officers of the major departments. The new officer is also required to answer assorted lists of written questions compiled by each department. The Indoctrination officer is furnished with the correct answers and corrects mistakes. In addition, the Indoctrination officer gives joint lectures to the officers and men on such pertinent subjects as the routine aboard, uniform regulations, military courtesy and station orders and memorandums.

The enlisted course follows the pattern for that of officers except that special stress is placed on matters peculiar to, and expressly concerning enlisted personnel. Because of the relatively large number of enlisted indoctrinees, they attend lectures given by the rep-

resentatives of the departments that cannot be visited. The small officer groups can visit each department concerned.

All pilots reporting to the station for duty involving flying are assigned to the Operations Department and given a one-month course in instrument flying and flight checks prior to their permanent station duty assignment. This course qualifies the average pilot for a Standard Instrument Rating. New pilots are also required to study the local Air Operations Manual and other pertinent aeronautical publications.

These courses have proved successful beyond the highest expectations. Comment from officers and men completing the course have been laudatory and appreciative. It makes them really feel "welcomed aboard" and gives them a complete knowledge of what will be expected from them.

### Divers Walk Sara's Decks Sunken Carrier Viewed Under Water

One year after the aircraft carrier *Saratoga*, one of the Navy's famed wartime CV's, was sunk by the atom bomb explosion at Bikini, divers went down to her deck to investigate just what caused her sinking.

The study is part of the Navy's Bikini Scientific Resurvey made the past summer to find out things that

could not be learned last year because radioactivity was too "hot."

Divers from the U.S.S. *Coucal* submarine rescue vessel, climbed around the flight deck of the old *Sara*—first men to reach her being Chief L. H. Lroux and Chief L. M. Plenel. They reported the carrier resting nearly on an even keel. Her mast can be seen a few feet beneath the surface of the shallow lagoon, where she sank last 25 July seven hours after the explosion.

The flight deck is covered with a layer of coral dust. The divers, who remained on the carrier's deck for 45 minutes said visibility was good up to 100 feet. Geiger counters to test radioactivity were lowered into the water ahead of the men. Each diver carried three photo film badges and a gauge that tabulates cumulatively the amount of radioactivity to which it has been exposed while on the man.



CIVILIAN WEEK-END FLIERS WORK FOR LIVING

### Reserves Sport Many Medals Week-end Fliers' Chests Are Covered

THESE boys look like fighting pilots in this regalia, but they also earn a living while not flying with the Naval Air Reserve Training Unit at Willow Grove, Penn.

Among them they have enough medals to plaster the chest of a South American general. Lt. (jg) Leon R. Grover, Jr., holds two Air Medals; next in line, Lt. Cdr. Robert F. Duffy, Lehigh engineering student, holds the British D.F.C. and two Air Medals; Lt. (jg) John Speidel, research and machine designer, holds the Navy Cross, D.F.C. and three Air Medals; Lt. Cdr. Charles H. Mester, two Navy Crosses and two Air Medals, and the last man, Lt. (jg) Charles H. Cardon, wears two Distinguished Flying Crosses.

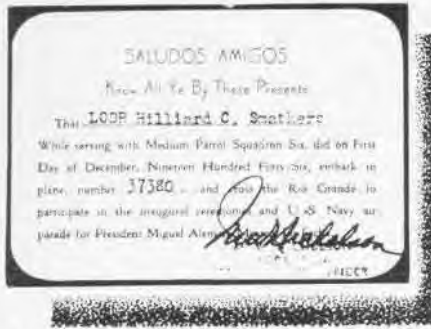

## Mexico Trip Wins Memento Squadron Gives Souvenir To Its Men

Pilots and crewmen of VP-ML-6 who made the trip from Barber's Point to Mexico City to participate in inaugural ceremonies for President Aleman were given plastic-bound certificates as a memento of the trip.

The size of an ID card, the certificates went to 36 officers and men who flew *Harpoons* via Alameda, Miramar and Corpus Christi. On the back is an inscription signed by the commanding officer certifying that the holder "While serving with Medium Patrol Squadron Six, did on the First Day of December Nineteen Hundred Forty-Six, embark in plane number . . . and cross the Rio Grande to participate in the inaugural ceremonies and the U. S. Navy air parade for President Miguel Aleman, Mexico, De Fecha."

On the face of the certificates, in Spanish, was the inscription granting the man an honorary membership in the Mexican Air Force.

## FASRON, Squadron Join Up Man Shortage Beaten by Job Pooling

VP-AM-1—Here's the way this amphibious patrol squadron and FASRON-115 met a personnel shortage problem. Both were in the same hangar and were the only Fairwing Four activities on the base. To provide adequate security and morale measures without working undue hardship on the men, the two:

1. Pooled watch officers and assigned the duty as Fleet Air OOD in turn. This officer was responsible for security of the hangar, planes and all government property of the two units.

2. Men of each unit were divided in two sections, giving sufficient men to provide watches. The squadron and Fason on alternate days provide duty watches.

3. Truck and bus trips made by either were made known to the other to save transportation.

4. A joint basketball team was made up of men from both units.

5. All squadron parties in the future will be joint ones.

6. A joint plan of the day is issued to give data to both, cutting paper work and making for easier distribution.

## Lightning Hits NATS Plane Samoan Run Struck by Blinding Bolt

It seems that NATS planes are coming into contact with lightning more frequently of late—and in widely scattered parts of the earth.

Latest report of lightning hitting a transport plane came from VR-8. Flying between Johnston Island and Samoa, the R5D piloted by Lt. Cdr. G. I. Butler was cruising at 8,000 through an equatorial front, in light rain falling from high overcast. Turbulence was light to moderate.

A flicker of light appeared dead ahead of the plane. A split second later a "spiraling" bolt of lightning appeared to strike the plane just below the co-pilot's seat. This was accompanied by a loud report which seemed to come from the belly of the plane.

There followed "light choppy turbulence similar to that caused by the slipstream of another plane," plus the usual strong ozone odor. The flash completely blinded the co-pilot for 30 seconds. The radio operator stated the lightning passed less than 12 inches from his face, across various antenna terminals.

After landing a ruptured and well-cooked front antenna insulator was found, plus loss of some 135 feet of trailing antenna. One passenger on the flight who managed to get to sleep despite the turbulence, awoke and thought the end had come for sure.

NANews reported four lightning bolts hitting a NATS transport off Bermuda (May, 1947) and another pilot said St. Elmo's fire burned a hole in the wing tip of his R5D last March near Amarillo, Texas.

## Hats Off To—

GCA Crew of NAS Agana Guam

A NATS R5D transport and an Army B-29 were flying on a collision course in the clouds over Agana air station. Neither knew the other was in the vicinity.

Men in the GCA unit at Agana spotted the two planes on their scopes and warned the VR-6 aircraft that another plane was near. Shortly after, the bomber emerged from a cloud and the NATS pilot, forewarned by the GCA crew, barely avoided a collision. Without their warning, it is considered that a disaster would have resulted.

## 1,000 Move Into Jax Area Banana River Closure Brings Shifts

NAS JACKSONVILLE—Aviation training units formerly located at NAS Banana River, now closed, have been moved to the Jacksonville area.

Advanced Training Unit VF No. 2, in *Hellcats*, is at NAAS Cecil Field. ATU VA No. 5 in *Avengers* and ATU VP-MS No. 10 in *Mariners*, are based at Jacksonville. Thus all advanced training except multi-engined bombers, which is at Whiting Field, is in this area. The transfer brings 250 student aviators, 100 instructors and 700 enlisted men and their families to Jax.



Another of the Navy's battle-tested carriers is being retired to the "mothball fleet," this time the *Shangri-La*, CV-38. It is on the West Coast awaiting inactivation. Her first action came in April 1945, when her planes supported the Okinawan invasion and conducted sweeps on Kyushu, Hokkaido, Honshu. After the war she joined the Magic Carpet run, carried F6F drones to the Bikini atom bombings and now closes her career.

## F8F In Wheels-up Landing Pilot Ignores Check-off List, Red Light

On a recent ferry hop the pilot of an F8F-1 made a wheels-up landing in a plane which had a total time of only 130 hrs. In his accident report the pilot stated that his radio was inoperative and that he consequently was unable to contact the tower for landing instructions. He followed another F8F in the traffic pattern and took a wave-off his first approach when he hit the slipstream of the preceding aircraft.

He raised his wheels and made another approach. He did not go over the checkoff list for the second approach and in spite of a red light from the tower, which he states he did not see, made an unintentional wheels-up landing.

NATS News Letter called attention to the fact that the first requisite in ferry operations is to get the plane to its destination safely. There is nothing to be gained from a cracked up plane or an injured or dead pilot.

Manual for Squadron Safety Officers is intended for individual pilots as well. Its "Foreword" stresses the vital importance of acquiring the habit of precision in everything. Under landing accidents, it states as one of the items of standard doctrine: "Require execution of check-off list for each landing. Planes that go around again sometimes forget wheels down."

The record does not state whether the radio failure occurred in flight. In any case, after it occurred, the failure to watch for visual signals from the tower can be charged to nothing except first class negligence.

## Aircraft Surveillance Radar Being Installed At Fifteen Air Stations

Another "life-saver" is soon to join the ranks of GCA, YG, radio ranges, etc., as things a Naval aviator can be happy about—surveillance radar.

Air Surveillance radar will work in conjunction with CCA, as a sort of lost plane finder. CNO letter, 694P413, dated 7 May, 1947 directs the installation of one AN/TPS-1B radar unit at 15 Naval air stations for aircraft surveillance. Type AN/TPS-1B gear, under optimum conditions can pick up an airplane some 180 miles from the station, and guide the plane into the GCA net. Normally, the pilot can expect the unit to have him on the scope at 100 miles. Under adverse weather conditions, the pilot can count on a reliable range of 60 miles. Any pilot worthy of the name, should be able to navigate that close to his destination.

The AN/TPS-1B radar is not specially designed for aircraft surveillance, and is slightly handicapped by a relatively slow scanning rate. In addition, the service life of the AN/TPS-1B is short and will require frequent replacement. Therefore, this type of gear probably will not be installed throughout the Navy, and those installations that are going in, may be replaced by superior models as they become available. However, the AN/TPS-1B is the best radar on hand for immediate installation and is a definite addition to air safety.

The 15 air stations already designated for surveillance radar installation are:

NAS WHIDDEY ISLAND	NAS MOFFETT FIELD
MCAS MIRAMAR	NAS SEATTLE
NAS NORFOLK	NAS SAUFLEY FIELD
NAS OAKLAND	NAS ATLANTIC CITY
NAS GLENVIEW	NAS SAN DIEGO
MCAS CHERRY POINT	NAS JACKSONVILLE
NAS QUONSET POINT	NAS KODIAK
	NAS BARBERS POINT

## Pre-Flight School Is Closed Ottumwa Units Moved to Pensacola

NAS OTTUMWA, Iowa has been closed and the Navy Pre-Flight School there moved to NAS PENSACOLA. (NANews July 1947). SECNAV recently directed Rear Admiral F. D. Wagner, Chief of Naval Air Training, to effect the change during the period of 1 June to 1 August 1947. Reduced Navy funds necessitate the action.

The Ottumwa station was commissioned 13 March 1943. Approximately 400 midshipmen have been undergoing pre-flight training at the station under the College program. Base personnel included 80 officers and 400 enlisted



I think it's about time De Gennaro got some shore duty!

men on duty in connection with the school.

## 'Privateers' Win 11 Games Cold Weather Spurs Kodiak's Quintet

VP-HL-10, ALASKA—Aleutian weather being what it is at Kodiak, it wasn't hard to keep interest up in the squadron's basketball season until the first of June. By that time the team had won 11 games and lost none.

Despite many operational flights, which made it hard to have the top players in every game, the Privateers won most games with visiting ships by large margins. To even things up, not more than two officers were allowed to play at one time, the others being enlisted men. L. N. Christensen, center, of Provo, Utah, was high man for the season with 18 points a game.

## Snow Static Is Bothersome NATS Pilots Find Way to Lick It

Snow static gave NATS plane commanders some trouble during the spring months, with each particle causing static as it hit the plane.

Pilots were advised that if it is impracticable to change altitude they should retract as much of the exposed surfaces as possible. Reeling in the trailing antenna reduces much of the static. Power may be added and the plane flown so the line of thrust merges with the line of flight and the shielded antenna used. Use of these measures often made it possible to hear radio signals under snow conditions.

## Panama Offers Many Sports Coco Solo Varies Recreation Program

The tropics are supposed to make men lazy, but personnel at Coco Solo, Panama, have a well-planned sports program of everything from water polo to weight lifting and roller skating.

The welfare and recreation department provides the gear for the 1900 athletically-inclined men stationed at NAS-NOB-FAW-3. This includes three swimming pools, a theater, tennis courts, bowling alleys and the basketball gymnasium. About 90 percent of the men aboard make use of these every day. The gym is considered the best on the Atlantic side of the isthmus.

Sports are geared to fit the weather. In rainy season, indoor sports like basketball, volleyball, bowling, pool, ping-pong, boxing, roller skating and weight lifting are encouraged. As skies clear, the men use the pools, and softball and baseball diamonds. Intra-mural sports and league meets with Army teams keep the interest high.



(With this issue, NAVAL AVIATION NEWS starts a new feature which it hopes will be popular with its readers—a flying visit to a Naval Air Reserve Training Unit somewhere about the United States. This month—Willow Grove, Penn.)

## Air Reserve Plays Outstanding Part in Local Civic Functions

THREE barefooted young boys on bicycles dismounted alongside a wire fence. Letting the bikes flop in the dust they thrust their faces up to the wires.

"That one's a Messerschmitt 262 jet, the sign says," one youngster commented.

"Those're Jap planes—a Zeke and a George," another put in. "Boy, I bet they ain't as fast as that Corsair out there!"

The interest of these three youngsters in the enemy plane exhibit was typical of the interest taken by the public at large in the Naval Air Reserve Training at Willow Grove, Penn., 20 miles north of Philadelphia.

One of the largest Reserve air stations in U. S. proudly points to its achievements in its first year's activities—such as 8,000 visitors on a cold February day for Operation Reunion and 75,000 at a model airplane meet. Probably the largest total of flight hours for a NARTU was amassed during June when its pilots flew 11,060 hours, with but two minor accidents.

Dropping in on Willow Grove in an SNJ, NAVAL AVIATION NEWS' traveling reporter found the station's quiet exterior belied the activity going on in its white buildings some distance from the operations tower. During war days squadrons from the Princeton, Cowpens, Belleau Wood and

F.D.R. trained there. Willow Grove then also was a resting spot for Ferry Command pilots flying Grumman fighters and torpedo bombers from Long Island west to the war zones.

About a year after the Jap surrender, 70 grim station keepers stood at attention and heard the NARTU commissioned, a bit skeptical about the whole thing, wondering how long it was going to last.

Skipper of the station then and now is Capt. C. M. Ewan, one of two U.S.N.R. CO's in the Reserve program. The other is at Jacksonville. Before many months had elapsed the station under his guidance had filled its quota of 446 station keepers. Today the station has 200 Organized Reservists and 900 enlisted men signed up, despite the fact it is not too close to any city.

Besides Philadelphia, Willow Grove also draws Reservists from New Jersey areas and provides planes and facilities for 75 USN pilots who come out from Princeton, Villanova and University of Pennsylvania to keep up their flight time.

Willow Grove has two fleet air service squadrons, one for CV types and the other for patrol planes. Its reserve squadrons include one VP, one VR, one CVG and one CVEG, plus two Marine squadrons, a total of 12 squadrons.

### Willow Grove Reserve Squadrons

- VF-58E— Lt. Cdr. Robert Duffy, C.O.; Lt. William Irwin, Exec.
- VF-79A— Lt. Cdr. Richard Griffin, C.O.; Lt. George Smith, Exec.
- VA-58E— Lt. T. J. English, C.O.; Lt. (jg) J. P. Speidel, Exec.
- VF-80A— Lt. David Shoemaker, C.O.; Lt. Louis Lepp, Exec.
- VA-79A— Lt. Cdr. Charles H. Mester, Jr., C.O.; Lt. J. Weiss, Exec.
- VA-80A— Lt. Richard Peters, C.O.; Lt. Frank Mayock, Exec.
- VP-ML-70— Cdr. John H. Guthrie, C.O.; Lt. Cdr. John R. Hess, Exec.
- VR-58— Lt. Cdr. Chas. Josephs, C.O.; Lt. Harry W. Pressel, Exec.
- Fasron 72— Cdr. Roland Harper, C.O.; Lt. Cdr. John Jonas, Exec.
- Fasron 172— Cdr. John M. Davidson, C.O.; Lt. Cdr. French C. Gray, Exec.
- VMF451— Major Henry S. Miller, C.O.; Maj. James W. Merritt, Exec.
- MGC15-17— Major Charles T. Proter, C.O.

RESERVE FLIERS AT WILLOW GROVE HAVE MANY TYPES OF OPERATIONAL AIRCRAFT TO KEEP UP THEIR SKILLS; CONTROL TOWER IS KEPT BUSY





SEE ANY OF YOUR SHIPMATES AMONG THESE SMILING FACES OF AIR GROUP 79-A PILOTS? THEY'RE ALL ATTENDING WILLOW GROVE SUNDAY BRIEFING

## Morale of Station Strong Factor in Its Efficiency

WEEK-END pilots who drop their lawbooks, tools and professional equipment to fly at Willow Grove have a large variety of planes at their disposal, including J2F, PBV, R4D, F4U, PV, F6F, SNJ and JRB. Maintenance of these planes, especially critical during the record-breaking June flying period, was handled by crews of mechs under Lt. D. F. Ascher.

That their job was well done can be seen from the fact the station flew 11,000 hours during June.

The first time the NARTU really got in the public eye came last September when a national meet of model airplane enthusiasts was held there. More than 2,000 contestants from every state in the union participated. When the day of the meet arrived, station officials were bowled over by the 75,000 visitors who swarmed out to see the meet. They swamped the station, like a tide of locusts.

The following February, the unit held open house to 8,000 visitors for Operation Reunion. Recently the unit secured the captured enemy planes, including two Arado cruiser-type float planes, from Patuxent and posted them by the front gate. Thousands of persons have stopped along the roadside to look at them, like the three bicyclists.

Another big event in Willow Grove's first year history

ENS. NAJEWICZ CHECKS TWO PBV CREW MEMBERS OUT ON RADIO GEAR



was the May-June period of active duty by Reservists. When the men turned out in huge numbers, rolling up 5,230 hours in May, Capt. Ewan and his staff saw something had to be done to handle the oncoming June rush.

They borrowed 20 SNJ's from the training command at Pensacola, flying down pilots in R4D's to bring them back so Willow Grove Reservists could get in their time. They did—11,060 hours worth.

Another outstanding event, in the eyes of the men attached to VA-79-A, was a flight of *Helldivers* to Providence, R. I., to visit the U.S.S. *Leyte*. Enlisted men and officers alike reported the trip a tremendous morale booster and expressed the hope that some day they could do their summer cruise duty aboard an aircraft carrier. VR-58 also helped ferry men north for the visit.

NARTU Willow Grove has its full quota of Navy Crosses, DFC's and other medals on its station keepers and Reserve fliers. Capt. Ewan's record stretches from the Caribbean to Alaska. At one time he was a senior pilot for American Airlines and once raced on Indianapolis speedway.

Executive officer of the station is Cdr. W. G. Corliss and senior air group commander is Cdr. L. R. McAboy. The latter officer saw service with VPB-107 anti-sub work around Panama and the Natal-Africa slot. His squadron was credited with 6 1-2 submarines. Corliss was navigation officer and later skipper of the *Bennington*, CV-20.

Under McAboy are several type-training officers with outstanding war records, including Lt. Cdr. Walter Haas, who

CAPT. EWAN CUTS CAKE HONORING FIRST BIRTHDAY OF AIR RESERVE





handles CV types. He won two Navy Crosses on the *Yorktown* and *Ticonderoga*. He fought at Midway and the Coral Sea with CAG-3, and later off Okinawa and Japan.

**M**ARINES at the station, VMF-451 and Ground Control Intercept Squadron 17, are under Major J. Frank Cole, whose war record stretched from early Marshall Islands raids to Okinawa, where his squadron, VMF-312, shot down 60 Japs.

Willow Grove, incidentally, has a live-wire public information man, Cdr. John Miller, ex-Olympics swim coach.

- 1** Five ex-combat pilots still flying: Nick Carofanello, Dick Stover, Don Tanner, Jim Bryner and Bob Babcock
- 2** George Rule shows fellow apprentice seaman, Howard Steacker, Jap *Kikka* twin jet which attracts the public
- 3** Air Scouts learn about new fire truck from W. S. Buhl, fireman specialist; many delegations visit the air station
- 4** James A. Quinn AOM1, Sgt. Donald T. Fitzpatrick and TSgt. John M. Buckley renew acquaintance with a Corsair
- 5** A. J. Spencer AOMT1 does some fancy turret ranging as W. J. Donlevy AOM3 looks on at NARTU ordnance bldg
- 6** Organized Reservists march out of Willow Grove's main gate on way to participate in two Memorial day parades

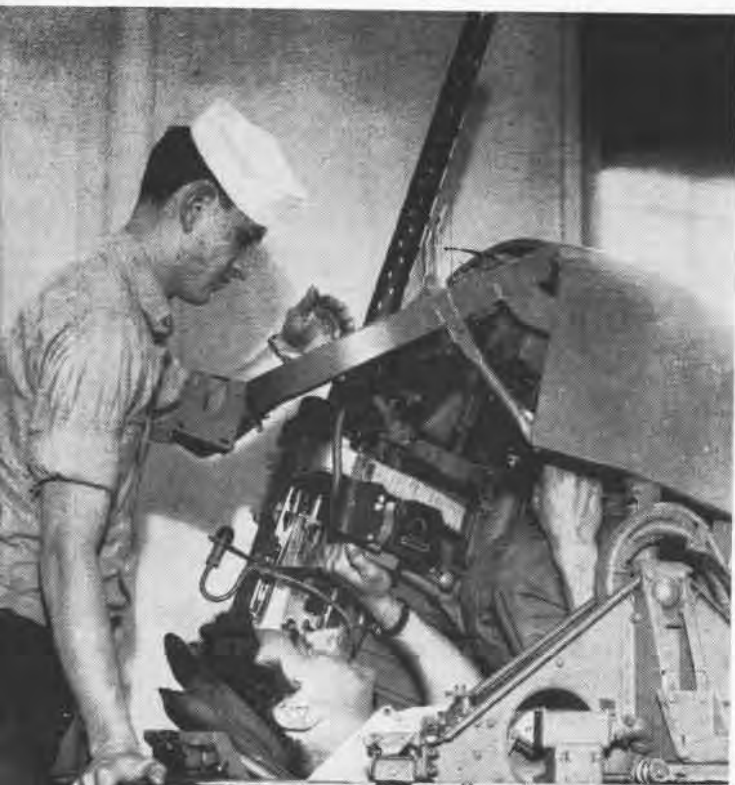

# RESERVE PROGRAM GETS GREEN LIGHT FOR '47-'48



'WEEKEND WARRIORS' AT NARTU ANACOSTIA MARCH DOWN THE LINE TO THEIR TRAINING PLANES

THE NAVAL Air Reserve Program for 1947-1948 has received the "go ahead" signal from Congress. Since the appropriation will not allow, in general, for the carrying out of all previously projected plans, new plans are now being formulated to insure that all funds are utilized with the utmost efficiency.

All established stations and units within the Naval Air Reserve Training Command will continue in operation for next year. The appropriation should also permit a certain amount of expansion in Naval Air Reserve facilities to accommodate areas which do not have stations or units.

Funds are available to train 9,098 officers and 40,656 men in the Organized Air Reserve components. There are also allowances for 823 officer and 9,849 enlisted "stationkeepers." Since the Appropriation Act did not carry any funds specifically assigned for active duty periods with pay for Volunteer Reservists, plans for these active duty periods have not crystallized.

Station complement of Reserve aircraft will be maintained at the planned level, the total number being 2,051 planes. These aircraft will comprise F6F-5's, FG-1D's, SB2C-4E's, TBM-3E's, PV-2's, PBY-5A's, R4D's, JRB's, J2F's, SNB's and SNJ's.

**New Stations**—Two new Naval Air Reserve Training Units are to be launched to serve the Akron-Cleveland and Louisville, Ky., areas. Naval air

stations will be located at the Akron municipal airport and Standiford field, a former AAF unit at Louisville.

**Marine Maneuvers**—Annual training maneuvers of the Marine Air Reserve are now underway. These maneuvers are designed to provide the Reserve squadrons with large scale operational training, and thus give both the Regular and Reserve organizations valuable experience in the problems of an actual mobilization.

Approximately 1,250 officers and men from Reserve units located east of the Mississippi River were scheduled to train from 15 to 29 August at the

Marine Corps Air Station, Cherry Point, North Carolina. A second group of approximately 1,100 officers and men from units located west of the Mississippi will hold similar maneuvers from 8 to 22 September at the Marine Corps Air Station, El Toro, California.

The schedule called for a day of area familiarization for all pilots and six days of gunnery, bombing and rocket firing, to be followed by maneuvers covering a two-day air-ground support problem and defense exercises.

**New Flight Records**—All Naval Air Reserve flight records were smashed in June. 120,363.7 pilot hours were logged by Reservists during this month alone as compared with the 94,364. hours which were chalked up during the first six months of fiscal 1947. This remarkable record, which was made possible by the many Reservists aboard for their annual training cruises, attests to the splendid teamwork shown by all departments in each Reserve unit.

Except for NAS St. Louis, where construction of new runways practically grounded all planes, all stations in the Naval Air Reserve Training Command hit new highs in flight time for any one month.

NAS WILLOW GROVE piled up the greatest number of pilot hours—10,932.1. Reservists at NAS OAKLAND and NAS SEATTLE tripled their time with 8185.4 and 6979.1 hours respectively. Pilot hours were more than doubled at NAS ALANTA 4038.2; NAS



V6'ERS SIC T. MILTIER AND ARMIC W. ADAMS PLUG RECRUITING AT NARTU NORFOLK ANNIVERSARY



COLUMBUS 5760.4; NAS DALLAS 7862.5; NAS DENVER 2991.5; NAS MEMPHIS 4122.2; NAS NEW ORLEANS 4303.1; NAS OLATHE 7584.4; and NAS SQUANTUM 7533.5. June box scores for the other stations show: NAS ANACOSTIA 3543.2 pilot hours; NAS BROOKLYN 4861.1; NAS GLENVIEW 8515.0; NAS GROSSE ILE 5720.9; NAS JACKSONVILLE 3559.9; NAS LOS ALAMITOS 8539.3; NAS MIAMI 2847.3; NAS MINNEAPOLIS 6352.3; and NAS NORFOLK 3561.5. In spite of construction on Lambert Field, NAS St. Louis came within 100 hours of time flown in May.

**Subscription Campaign**—All hands are cooperating in getting the word to Reservists concerning the Reserve Edition of the NAVAL AVIATION NEWS. Civilian friends and personnel on inactive duty are also helping. One of "Buzz Sawyer's" pals was recently depicted reading the Reserve issue in that popular comic strip. Congressman Edward H. Jenison of Paris, Illinois, an Air Reserve officer, had his picture taken writing out a subscription.

#### We "Dip Our Wings":

- To NAS DALLAS—for its excellent first year record. No person in the Organized or Volunteer Reserve received any type of bodily injury.
- To NAS St. Louis—for valiant assistance rendered during the worst flood to hit the Missouri Valley in 103 years. An average of eight pieces of rolling stock and the crews to man them were on duty in the stricken area. Personnel helped evacuate people and livestock. Activities extended as far west as Kansas City.
- To NAS LAKEHURST—on the commissioning of NARTU (LTA) which took place on 2 June. Cmdr. R. C. Gossom,



YTC ROSE LENZ 'SELLS' A NAVAL AVIATION NEWS SUBSCRIPTION TO CONGRESSMAN E. H. JENISON

USNR, is Officer-in-Charge and Lt. G. Zeitler, USN, is Executive Officer. Three trainees took a free balloon flight during their June cruise.

- To NAS GROSSE ILE—for its winning pistol team. This team has bested all comers except the Detroit Police Team and recently won the Grand Rapids Trophy Competition over other Naval activities in Michigan. The team is now ready to challenge any pistol team in the NAR Command (or any Command); any takers are invited to write the station.
- To NAS OAKLAND—on its fine record for the first year. Although a few planes were lost, there were no serious personnel injuries. This record was not even marred on 13 June when 1st Lt. J. C. Webb, USMCR, had to bail out over Death Valley

due to engine trouble. Although he had to walk across the desert for 23 hours without water to get help, he was only in sick bay for 36 hours due to dehydration and exposure.

- NAS DENVER—for commissioning three new squadrons during the June "open house." These squadrons were VP-ML-75, VR-75 and VP FASRON-155.
- To NAS MIAMI—for the excellent record of its Marine pilots. In the 3,939.3 hours they have flown this year the only mishap was a forced landing due to material failure, which left the pilot uninjured.
- To NAS NEW ORLEANS—for the alertness and adaptability of its personnel. A stationmaster invented a "Flightimeter," which affords rapid translation of odd minutes of flight time into tenths of an hour. Ex-Army specialists, who enlisted in the Naval Air Reserve at an equivalent rate, are proving to be not only enthusiastic but also capable trainees.

**Anniversary Events**—The Naval and Marine Air Reserve celebrated its first birthday in June. Through massed plane parades, air shows and station "open houses," Reservists throughout the country, acquainted the public with the program and achievements of the Naval Air Reserve.

In New York City millions of people witnessed a massed flight of more than 100 planes from Brooklyn and Squantum and thousands attended the air show held at Floyd Bennett Field. On the West Coast Californians from Los Angeles to San Francisco watched the parade of 131 aircraft from Los Alamitos and Oakland.

Reservists from Dallas and New Orleans saluted the citizens of Louisiana, Missis-



'HERE'S HOW IT'S DONE', CHAMPION JUNO STOVER TELLS SAILORS AT LOS ALAMITOS OPEN HOUSE

(Continued next page)

issippi and Alabama in a 1300-mile flight. NARTU planes from Miami, Jacksonville and Atlanta joined in a "show of strength" over Miami, but, due to inclement weather, staged flights over local communities in individual groups.

High cover was flown over Chicago by planes from Glenview and Minneapolis. Pilots from the latter station also toured their home State. Reservists from Grosse Ile managed to put 79 planes into the air within 25 minutes for an air parade of Michigan. Memphis and Olathe combined forces for a massed flight over that vicinity.

Two air shows were staged by Seattle, one before 175,000 spectators attending the National Sprint Regatta on Lake Washington and the other before some 20,000 guests at the NARTU "open house." Denver's air show and "open house" was attended by over 5,000 people.

The elaborate plans of Anacostia, Willow Grove and Norfolk for a combined flight were rained out, but all reported successful birthday celebrations. Despite drenching showers 3,119 visitors turned up at the Norfolk festivities.



LATEST CORSAIR HAS TWO NEW AIR SCOOPS

### F4U-5 Goes Into Production Most of Changes Made Inside Plane

It looks about the same on the outside, but inside the new F4U-5 Corsair, now in production for the Navy at Chance Vought, has numerous changes that make it faster and a better climber.

The only outward difference in appearance is two air intake gills at the lower leading edge of the cowling, whereas the F4U-4 had one at the bottom. The latest version has the P&W R-2800-E Double Wasp engine and improved Hamilton Standard four-bladed prop.

Greater pilot comfort is provided by a new design job on the cockpit. Power-actuated units include the cockpit canopy, control surface trim tabs and the auxiliary hydraulic pump. The new adjustable seat has folding arm rests and brake pedals can be swung down for leg-rests on long flights.

From a maintenance standpoint, changes include easier accessibility of radio equipment, cockpit heater and other installations, through a large access door behind the plane's cockpit.

## 'DARK SHARK' TURBO-PROP SETS RECORD



RECORD-BREAKING FIREBALL SHOWN ON WAY UP

THE SHARK-NOSED Ryan XF2R-1, first turbo-prop aircraft in the Navy, set what is believed to be an altitude record for that type plane recently when it reached 39,000 feet while on a performance test by a company pilot.

In the nose of the plane is a TC-100, General Electric turbine engine, while the GEI-16 jet engine developing 2300 pounds of thrust is in the tail. On its test, the *Dark Shark Fireball* used both engines, reaching the record height in 23 minutes.

Along with the jet engine, gas turbines promise to be the power plants of future fighting aircraft, although they are going through development problems the same as other engines in the past. They are expected to do as high as 10,000 hp., double that of conventional reciprocating power plants.

Ryan Aircraft Co., reported the XF2R-1 had climbed to 10,000 feet in less than two minutes, approaching the record for climb to that altitude held by an F8F which got up there in 100 seconds at the Cleveland National Air Show after a take-off run of 115 feet.

The XFR-4, latest of the line of *Fireballs*, has the new Westinghouse 24-C



AIR SCOOP BENEATH PILOT FEEDS FR-4'S JET

jet in the tail and a Wright 1300-hp. engine in the nose, it has been announced. This plane has a flush entry duct system. When the rear engine is not being used, its air intakes are closed by electrically-operated sliding doors, reducing drag. By putting the more powerful 24-C jet engine in the plane, about 100 mph. is added to the new *Fireball's* top speed, by making it faster and better at climbing than the XF2R-1.

As can be seen in the illustration, the air intakes are in the fuselage instead of in the wing-root leading edge as was in the FR-1. An electric motor opens the doors whenever the jet engine is started. The closure keeps the drag of air from windmilling the aft jet engine while using the front engine.

### Transport Gets More Power Constitution Gets New Wasp Majors

To give the *Constitution* more power, four P&W Wasp Major engines are be-



BIGGER ENGINES THAN THESE GOING IN PLANE

ing installed in the Navy's 92-ton transport plane. They will have 3500 hp. each instead of the 3000 hp. developed by present engines.

The new engines are expected to reduce the plane's takeoff run by 12% and its rate of climb 10%. The *Constitution* has made 23 test flights covering 50 hours since its maiden flight from Lockheed plant last November.

A new feature to be installed will be pre-rotation mechanism on the four-wheeled tandem main landing gear. Small electrical motors will start the wheels rolling to reduce friction when the plane hits the runway. The R60 will be turned over to Patuxent for testing, then put into trans-Pacific service with NATS. A second model of the *Constitution* is being fitted out completely and will go direct to NATS.

The Navy is also securing from Lockheed a P-80 jet plane to use in chasing guided missiles fired from Point Mugu, Cal., out over the Pacific ocean.

# BASIC TRAINING IN SNJ PRAISED



RELIABLE SNJ CROWDS OUT BIPLANE N2S (ABOVE) AS A TRAINER FOR BASIC TRAINING STUDENTS

## Faster Operational Planes Require A Stepped-Up Training Program

THE NAVY'S new experimental program, using SNJ's for basic training of pilots instead of N2S *Yellow Perils* is winning the approval of instructors and students alike at Corpus Christi where the plan is being tried.

"In the opinion of instructors and students, the program is one of the greatest things to have been adopted in the training command," according to a report from NAAS CABANISS FIELD. "The program is an experiment, and as such must prove its worth. Of the 130 students now undergoing the course, it can be said truthfully that indications certainly are good."

The idea behind using the faster SNJ to start a tyro student out in flying instead of the slow old biplanes is really a double one:

1. With the increasing tempo of aviation, in which the pilot must fly fast jets instead of the slower fighters of World War II, the whole training program has raised its sights. The transition jump from present trainers to jets is too great.

2. Psychologists believe starting out a student in a plane with all controls found in an operational plane may prevent future accidents. If he must think of retracting and lowering his wheels from the start, his first reaction in an emergency will be correct. In a fixed-wheel plane he never has to think of wheels, and the first reflexes he develops thus may be inadequate when he gets in faster planes. The same goes for controls like flaps, propeller pitch, radio equipment and switching gas tanks. The N2S pilot does not have to bother about any of them.

The Navy considers the move to change to a swifter basic trainer one of the most progressive steps in 35 years. The RCAF experimented with the idea back in 1945 and it is understood the Air Force will discard its biplanes in the near future.

Since March, 1947, at Corpus, the Basic Air Training Command under Rear Admiral Clifton A. F. Sprague, has been conducting an experimental primary flight syllabus with more than 100 student aviators. When first started, the idea caused some apprehension among veteran primary flight instructors. As the students began to get into the syllabus their mastery of the more complex SNJ created considerable enthusiasm in the command.

There are many disadvantages in learning to fly a very light biplane, when ultimately the pilot will have to

handle heavy, high-speed monoplanes. The 6,000-lb. SNJ is double the weight of the N2S and has many flight characteristics of combat planes.

Light biplanes have been designed aerodynamically to allow the beginner to make errors without causing serious difficulty. However, this factor causes numerous bad habits to be formed which must be unlearned.

UNDER the experimental training program, much of the first 80 or 90 hours in the air is devoted to flying under simulated emergency conditions. During this period, the aviator's reaction to an emergency situation becomes instinctive and spontaneous. Aviation Medicine research showed that reactions developed early in flight training which are normal and safe in a biplane become extremely dangerous when applied in an emergency in a heavy plane.

Of necessity, the student will be longer in dual instruction before he is ready to solo but it cuts the total time before he gets his wings. Inept students are eliminated earlier and a saving in money made, at the same time giving the student a chance to get in some other better-suited field.

The N2S will be used in the future only for check-outs in inverted spins. The student will get 114 hours of flight time in an SNJ, compared to 124 hours under the old syllabus, 72 hours in N2S and 52 in SNJ.

The Navy has two new trainer planes whose status in the training program is awaiting classification. One is the XNQ, which has been approved in Patuxent tests. The SN2J, a faster, operational-type version of the SNJ, is being flight evaluated by the manufacturer and Patuxent Test Center.



**N2S** Cockpit of *Yellow Peril* carries few instruments to worry pilots



**SNJ** This is what he has to master when he steps in cockpit of SNJ

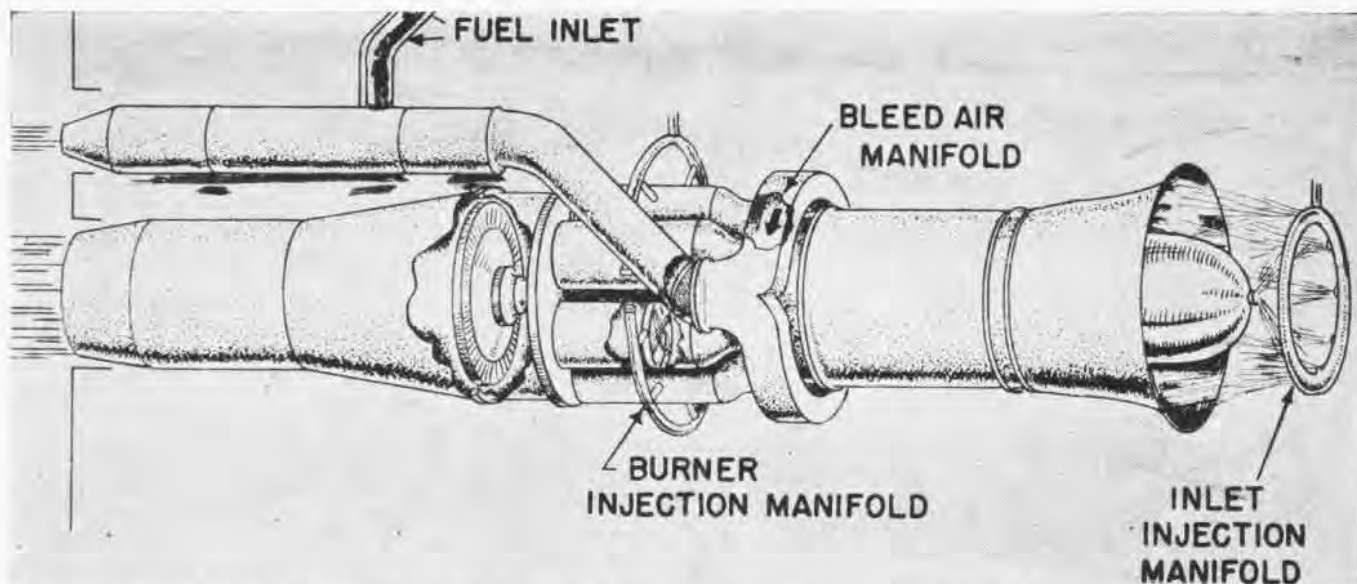

IN BLEED-OFF SYSTEM EXTRA AIR IS DRAWN OFF AND BURNED IN AUXILIARY COMBUSTION CHAMBER AT HIGHER TEMPERATURES THAN IN MAIN ENGINE

## JET HOTFOOT

**TURBO-JET** engines power the world's speediest piloted planes, but paradoxically, the turbo-jet is very sluggish at low speeds. Slow acceleration during take-off and wave-off is not of major importance to the land-locked jet plane operating off a nice long runway.

Carrier planes, however, must get airborne fast lest they run out of deck space a little early. Wave-offs are common occurrences in carrier operations, and they come when the plane is in a vulnerable near-stall approach attitude.

When throttle is applied at a critical point in a carrier landing, the pilot wants immediate action. So, the restrictions of a carrier deck couple with the inherent slow acceleration of turbo-jet engines to present a real problem to a Naval aviation rapidly becoming

jet-propelled. Conversion has begun.

It all boils down to a demand for more power during take-off and emergencies than the present-day turbo-jet engine affords. "Thrust augmentation" seems to be the best answer at the moment.

There are a variety of methods for boosting jet thrust. However, three types of augmentation are receiving the lion's share of study at the present time. They are: *Water injection*—the spraying of coolants into the compressor inlet or into the combustion chamber; *Bleed-off*—the bleeding of air from the compressor discharge into an auxiliary combustion chamber from which products of combustion discharge through a nozzle into the tailpipe; and *Tailpipe burning or after-burning*—the burning of additional fuel in the tail-

pipe of the engine. These three methods are receiving a great deal of attention from BuAer and NACA. The Army utilized water injection to produce their recent P-80R speed record of 623 mph.

Water injection operates on much the same principle in jets as in piston engines. A mixture of water and alcohol is sprayed into the air inlets just ahead of the compressor, cooling the air and increasing the density and permitting a larger volume to be handled, ergo, more power. In addition, more fuel can be burned because the air is cooler. This mixture, may also be injected directly into the combustion chamber, causing a reduction in the turbine inlet temperature and permitting a greater amount of fuel to be burned. From 15 to 25% additional thrust has been obtained with these methods. For 30 gallons of water injected per minute, a 15% thrust

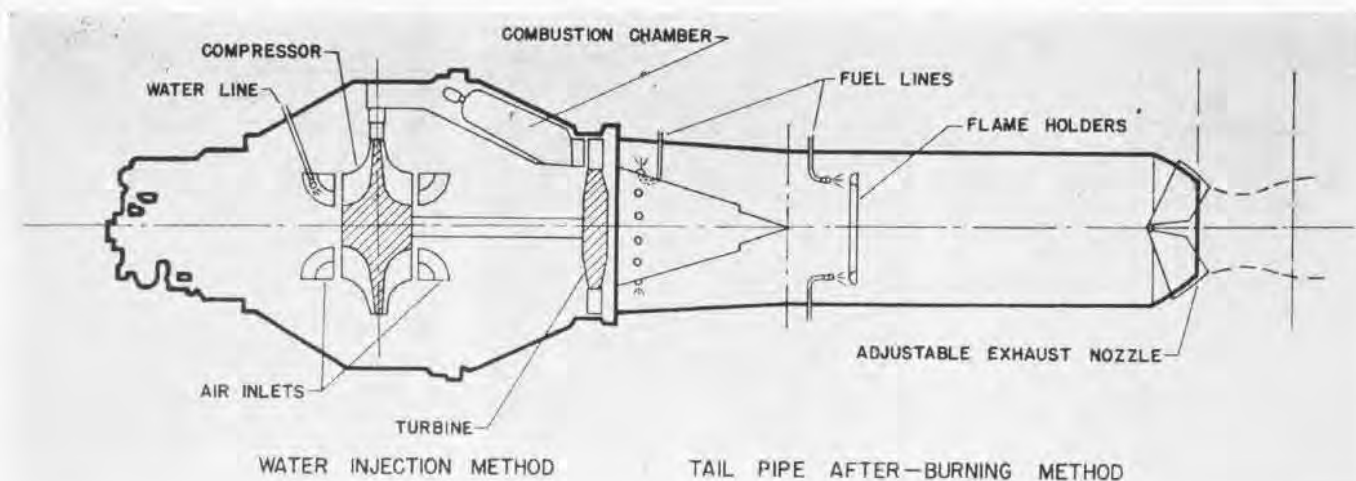

THIS LINE DRAWING ILLUSTRATES SIMPLY THE MECHANICS OF A WATER INJECTION SYSTEM AND TAIL PIPE OR AFTER-BURNING THRUST AUGMENTORS

increase is realized, while specific fuel consumption, i.e., ratio of pounds of fuel per hour per pound of thrust is not appreciably changed.

On the other side of the ledger, the weight of the water-alcohol mixture is a considerable factor. For 10 minutes of operation using water injection, a ton of water-alcohol would be used. The jet plane, even as you or I, is "carrying quite a load" when water-alcohol is used to obtain that extra kick.

About four times more air is drawn into the gas turbine than is used for combustion purposes. The additional air is used for cooling. In "bleed-off" this extra air is drawn out of the engine just ahead of the combustion chamber and after final compression stages and led into an auxiliary combustion chamber, where fuel is mixed with it and ignited. It is then channeled into the tailpipe with the exhaust gases from the main chamber.

The mass of air in the auxiliary chamber is ignited under the same pressure as that in the main combustion chamber. It results in a large mass of air being heated to more than twice the temperature that it would have been heated had it remained within the main engine. This gas is then discharged at a much higher velocity, thus increasing the thrust of the overall engine.

NACA is experimenting with a system of replacing the extra air that is



FUEL INJECTOR IN AFTER-BURNER INSTALLATION

bled from the main combustion chamber by injecting water into the chamber. The volume of generated steam replaces the air. Experiments with a turbo-jet engine showed that a 66% increase in thrust can be obtained with a total liquid consumption of 8.9 pounds per hour per pound of thrust. The water that must be carried, again seriously limits this type of augmentation.

In "tailpipe burning" additional fuel is injected directly into the hot stream of gases after they have left the turbine wheel and are headed for the ejection nozzle. Temperatures are restricted to 1500° F. at the turbine wheel due to limitation of material used. In the tailpipe, no such tempera-

ture restriction is imposed, the temperature runs normally around 1200° F. With after-burning, temperatures are raised to about 3500° F. after fuel has been injected and ignited. An increase in thrust of from 30% to 50% is claimed. As the fuel is burned under low pressure and the effect is to increase jet velocity, lower propulsive efficiency is obtained, and consequently it is relatively uneconomical. One hundred percent more fuel is burned for a 30% jet thrust increase. Of course that extra 30% of thrust might be worth a great deal in an emergency.

Because of the change in the discharge gas density when the tailpipe burner is operated, it is necessary to provide an adjustable area discharge nozzle for permitting change from the non-burning to the burning condition in flight. A workable adjustable nozzle has been developed by NACA.

Ryan Aeronautical and Solar Aircraft have developed after-burners which are now undergoing wind tunnel tests in conjunction with installation on the Westinghouse 24-C engine.

Another potential method of thrust augmentation is the use of the conventional jet assisted take-off unit, as used during the war. However, smoke from the JATO units precludes its general use aboard carriers. Study is continuing in an attempt to perfect a smokeless charge that will work well.

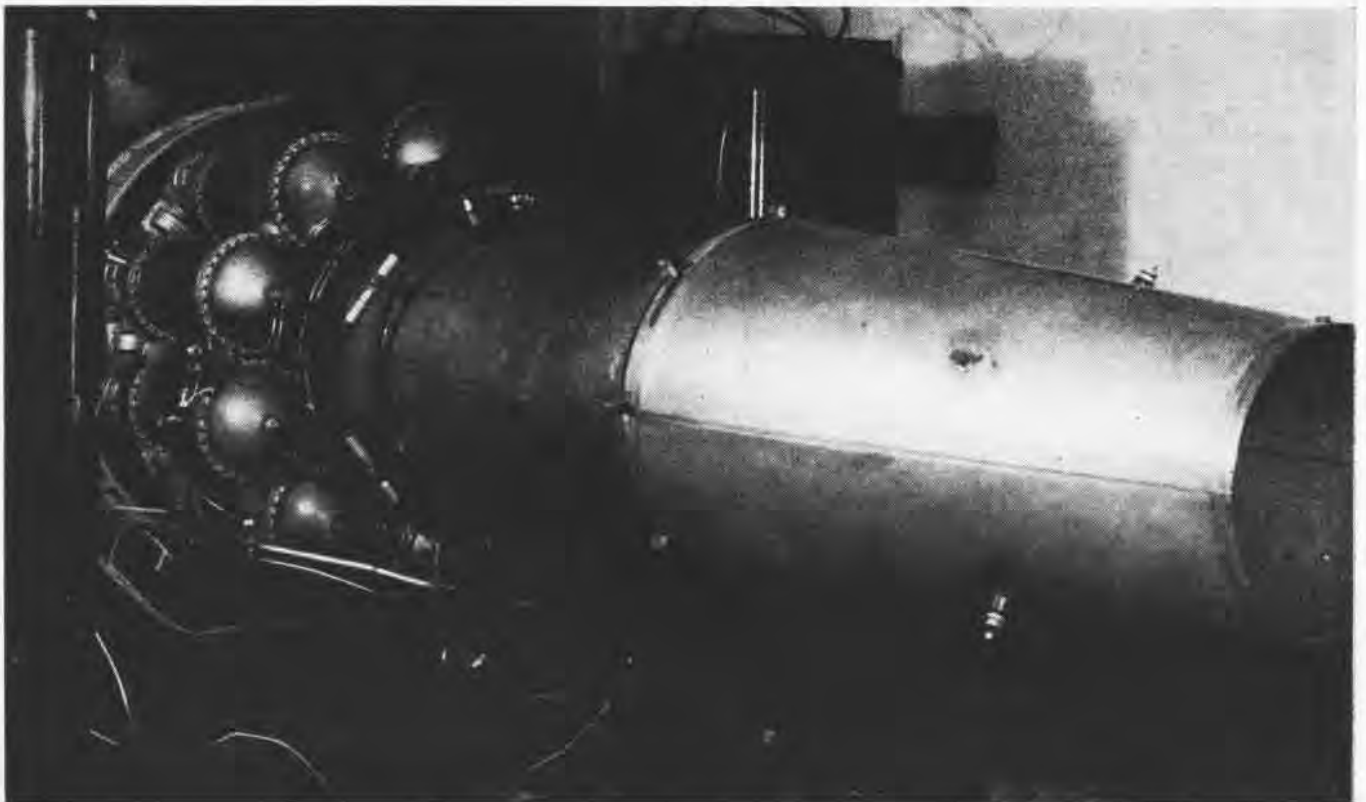

FROM THE OUTSIDE THIS AFTER-BURNER INSTALLATION ON AN I-16 LOOKS JUST LIKE AN ADDITIONAL LENGTH OF PIPE ADDED TO THE TAIL PIPE

# NAVY PLANE SAVES YOUTH'S EYESIGHT

THIS is the remarkable story of a beautiful Navy triple play, spread over thousands of miles, and entails just about all the factors that could enter into such a cinema-like rescue.

It started at Dutch Harbor, a somewhat bleak Aleutian outpost familiar to thousands of war-time Naval personnel. A 19-year-old boy, Peter Blewett, son of a civilian worker, was playing with a hand grenade when it exploded. It sprayed his whole right side and face with steel splinters and fractured his left leg.

Doctors concluded the only way to save his eyesight was to send him to Seattle as soon as possible. The Commandant of the 17th ND at Kodiak was contacted and he sent a staff R4D to Dutch Harbor to get the child.

Thick evening fog settled in on the base at Kodiak and clung to the ground so that even GCA was unable to land any planes at that field. The mercy R4D with the boy aboard was among these. Fortunately even NATS planes had to land at Anchorage.

Lt. (jg) J. W. Entrikin, plane commander of trip No. 0569 returning from Adak, landed at Anchorage to refuel before proceeding to Seattle. The boy was transferred to the NATS R5D from Adm. Daubin's plane and within half an hour the boy was winging south.

Fate and gremlins, however, naturally could not be expected to leave such a seemingly perfect play to run an unobstructed course. A terrific low pressure area moving across the Gulf of Alaska set up strong headwinds, turbulence and icing for the plane to travel through. To make matters worse, two hours out of Anchorage Entrikin had to feather his No. 1 engine when it began to lose oil rapidly. Nevertheless, nine and a half hours after leaving Anchorage the VR-5 plane touched down at NAS SEATTLE.

THE PLANE commander had radioed in long before his arrival, informing authorities of his critical cargo. Operations there quickly rigged the interior of its utility SNB to accommodate the child. Seven minutes after Entrikin had landed under close supervision of Lt. Koelling, MC, and his corpsman, the boy was aboard and 23 minutes later was at Kitsap county airstrip and Peter was en route to Bremerton Naval Hospital in a Navy ambulance.

The hospital staff also gets credit for some good work. Diagnosis disclosed



SEATTLE SNB TAKES ALASKAN BOY TO HOSPITAL

a metallic foreign body in the posterior portion of the child's eyeball. A delicate operation was performed which necessitated cutting an eye muscle and using an electro-magnet to remove the hand grenade splinter. Hospital records indicate the boy's eyesight now is good and the compound fracture healing.

## Saipan Shows Off Aviation Light Carrier Is Busy at Pensacola

NAS PENSACOLA—After six months of duty attached to the training command, the U.S.S. *Saipan*, CVL-48, has piled up 10,378 landings, qualified 1,578 flight students as pilots and checked two hundred civilians out in the rigors of sea duty.

The latter activity is strictly a sideline, outstanding citizens from various inland cities being taken along for the ride to absorb some Navy knowledge when the *Saipan* puts out for qualifications. The trips are strictly cash-and-carry for the visitors, nothing special being put on for their benefit. All pay their own way.

The visitors aren't just big shots. One happened to be a father whose son was due to make his six landings on that cruise. Many are seeing Navy ships for the first time. The result is a better understanding by John Citizen of what the Navy is doing. The *Saipan*, fresh from commissioning, replaced the veteran *Ranger* six months ago and the latter went into retirement.

## Alert Crew Saves F8F Pilot Flier, Plane Salvaged by Fast Action

NAS QUONSET PT.—Quick action on the part of the boathouse crew in answering a crash alarm recently saved a pilot's life in what might be record time and also resulted in quick salvaging of the plane.

At 1140 the alarm system signaled a crash and 35 seconds later two crash boats were under way from the boathouse. A third stood by for the medical officer on hand. Four minutes later the

pilot was picked up by Claude Amereson, BM 1C, on the first boat. The second boat picked up the pilot's gear and marked the spot where the *Bearcat* had sunk.

Twelve minutes later the pilot had arrived at the boathouse and departed for sick bay. In less than three hours the crashed plane was on the deck of the *Maryann* and en route home.

## Navy Planes Sank 619 Japs Official Survey Shows War Sinkings

The final box score is in on the Japanese war and what the U. S. Navy did to the ships of the Rising Sun. A summary of Japanese naval and merchant shipping losses has been prepared by the Joint Army-Navy Assessment Committee.

The report showed Navy-Marine aircraft sank 172 of the 611 Jap naval vessels which went to the bottom, submarines accounted for 201, although the total tonnage by subs was less than that sunk by aircraft—540,192, to 724,638.

In merchant shipping, submarines were far ahead with 1113 ships and 4,779,902 tons, to 447 ships and 1,608,959 tons for Naval aircraft. A total of 32 vessels were sunk by Army, Navy and Marine aircraft in combinations and 58 more were sent to the bottom by aircraft and other agents, such as submarines, mines, or surface craft.

Carrier based Navy planes sank 161 Jap naval vessels while land-based sank 11. Carrier planes blasted 359 merchantmen and land-based 88. Army Air Forces planes unaided sank a total of 70 naval vessels and 240 merchantmen.

## Book to Tell Story of 'Lex' Steichen's Photos Illustrate Volume

A photographic log and personal narrative of the exploits of the U.S.S. *Lexington* has been prepared by Capt. Edward J. Steichen, USNR (Ret.), former director of photography for the Navy. The book will be published by Harcourt Brace in October under the title "The Blue Ghost."

The book will contain more than 100 photographs taken of and aboard the *Lexington* by Capt. Steichen. The photographic section which he headed during the war took hundreds of photographs for use in NAVAL AVIATION NEWS. A large number of the finest photographs taken during the war of the Navy's air arm were shot by Capt. Steichen and his staff of cameramen, many of them outstanding commercial photographers before the war and now.

# AND THERE I WAS...



## Excuse My Dust!

WHIZZING along with a 40-knot tailwind, the J2F-2 patrol course passed directly over the active volcano Kilauea (el. 13,300). Normally, this flight circuted the island low, but the radioman on his first war patrol wanted to see the crater, and the pilot was obliging.

The plane scooted up a fissure climbing steadily, clearing the terrain by a safe margin and soon reached the top. Immediately after passing the rim the plane plummeted into the crater! Only by using full throttle and adroit control did the pilot manage to level-off inches above the boiling lava.

At the opposite bank, the plane turned precariously, engine sputtering as the pilot frantically worked the wobble-pump to force fuel into the lines as it vaporized from the terrific heat. Gaining a bit of speed the pilot tried to climb the steep slope to the rim, but failed as a wingover and rapid recovery found him again within inches of the turbulent lava and closing on the opposite side.

During the next few futile attempts to clear the rim, it dawned on the pilot that the two depth charges nestled beneath the wing limited to the J2F to a ceiling of about 8000 feet and only the tailwind up-draft had enabled the plane to top the volcano rim, and, even now, only the effect of the lava's heat lifting the air kept the plane above the seething lava. (Drop the charges you say? Yeah! and set off an eruption)

The last of the fuel was being consumed by the sputtering engine, and the pilot was planning to land in the crater and skid to the edge so that he

and his radioman could hope to clamber over the rim before the gas tanks exploded; when a sightseeing *Flying Fortress* soared along the rim.

Acting rapidly, the Army pilot maneuvered the *Fortress* to straddle the *Duck* with the mighty blast of his four-engine slipstream as the J2F made another vain attempt to pull over the rim. The boost did the trick, and the grinning Navy pilot glided the lumbering *Duck* devoid of gas to a successful landing at the sea-level Hilo airport.

Thereafter two Navy airmen staunchly defended Army pilots against all derisive comment, much to the amazement of their shipmates.

LT. J. E. SMITH

NAS JACKSONVILLE

## Step Out, But Step Gingerly

We who were about to be civilians lined up in front of the counter at the Separation Center.

"Report back to Administration promptly at three o'clock!" They'd told us that three times, so there we were . . . one captain, five commanders, four lieutenant commanders, one lieutenant, one lieutenant (jg), one ensign and one warrant.

We'd had our blood tested, our chests X-rayed and the dentist had counted our molars. All we needed to make us civilians, first class, were "ruptured ducks" and signatures on our final orders separating us from the Navy.

It was five minutes after three when the duty yeoman spoke: "I'm sorry gentlemen," he said, "you'll have to wait. The officers that sign your papers were ordered out to see a picture on the atomic bomb."

## A Helluva Way—

NAS SAMAR in the Philippines was a wonderful spot to operate from—that is, if you like to fly in the rain, for it rained most of the time. As usual, during a particularly torrential downpour one afternoon, a couple of *Privateers* were caught up in the storm. When the first plane arrived over the area and called in, the visibility was very sad indeed. However, the tower cleared him for a low altitude, close-in shot providing he could keep the strip in sight.

On the ground we couldn't see the airplane until suddenly there it was touching down on the far end of the runway. Everyone breathed a sigh of relief and turned to go back to the Ready room when someone yelled, "Look . . . the other plane!" And sure enough just landing on the opposite end of the strip was the second *Privateer*. The two 4Y's thundered toward each other and the spectators got

set for a big noise when they came together.

The pilots of the planes saw the other too late to do anything except ride the starboard brake in an effort to force their ships off the runway. But try doing that with 30 tons of airplane in about five seconds. Nevertheless, when the two planes met directly in front of the tower, they miraculously passed each other with possibly a full inch to spare.

Someone drove out to pick up the pilots and asked Lt. Comdr. C. C. Callaway, our Exec. and pilot of the first plane, what he thought of when he saw the other plane approaching.

"Well," he said, "I thought of the farmer who was working in his field one day, when he saw a train coming hell-bent-for-election down the track. Then he looked in the opposite direction and here came another train lickety-split and headed for an inevitable collision. The old farmer scratched his head and muttered, 'Now that's a hell of a way to run a railroad.'"

## Beach That Bull

One calm night about 2200 at NAS Coco SOLO, a goggle-eyed sentry reported a strange story to the SDO of a seaplane outfit. He was sober and fairly coherent, but the story warranted investigation. The report suggested a real, live bull was attempting to make Ramp One.

A quick check with the tower and operations revealed there were no ETA's on such a type and that this particular craft had no clearance for ramping. Therefore a harried SDO made ready to get to the bottom of things.

Throwing a coil of line into a jeep, and with visions of a barbecue in mind, he made off with a wild Texas yell. His quarry by this time had made the ramp and was moving off at an estimated 20 knot ground speed and was in no mood to be captured.

Assistance was called for, but it seemed that all the station's duty toreadors were on liberty. The Marines were called out and after a two-hour impromptu roundup the beast was still his own boss, although there were by then almost a dozen assorted types of transportation in the field. The chase ranged from one end of the station to the other, and the noise grew in volume until the station commander was forced to order the chase abandoned.

As the order was received at the scene of action, the bull was being driven off Ramp Two in spite of his protestations. The last seen of the now-exhausted bull was a wake in the moonlight as he set his course for the nearest land on his return voyage. Bon voyage, senior el toro!

This may seem like a lot of bull, but all hands swear it is true.

◇

VR-5, SEATTLE—The hit tune of yesteryear, "June in January," was reversed by Aleutian weather recently. It took Lt. Cdr. Douglas eight hours to make a normal five-hour flight because of 72 mph. headwinds. Other pilots met with severe icing.

# NAVY DOCTORS STUDY EFFECT OF JET VIBRATION



AS A GE I-16 JET ENGINE RUNS AT 15,000 RPM, VOLUNTEERS TAKE THE SHAKE NONCHALANTLY

working on all-weather landing aids. Here again the human equation must be considered. High-frequency vibrations intense enough to condense fog particles won't be a popular method if the neighbors of the airfield feel the effects.

Since the studies at NAES PHILADELPHIA began late in July, no results are yet available. No harmful effects of jet engine vibration, even under the exaggerated conditions of the tests, are anticipated. Thus far, in the early stages of the investigation, the helmet-clad volunteers standing at their chalked-out positions around the engine, are taking it nonchalantly and have experienced no deleterious effects.

While a certain amount of discomfort may be felt in the vicinity of high-frequency vibrations, medical experts have expressed the belief that only constant, prolonged exposure—unnecessary in operational work around jets—would be likely to have any lasting or injurious effects. Reports of nausea are more probably traceable to exhaust gases, and projects are underway to analyze these gases.

Although there has been much guessing about possible ill effects to crews subjected to jet engine high-frequency vibration, no data are available to substantiate any theories. It is expected that any precautionary measures needed for protection will be developed as a result of the studies underway.

CONSTANTLY on the alert to protect health of naval aviation personnel, BuMED's Aviation Medicine division is checking up on scuttlebutt about physiological effects of jet engine vibration. To allay fears which develop with ignorance of a given situation, tests are being conducted by Aero Medical Equipment Laboratory at Philadelphia Naval Air Experimental Station. In these tests, volunteer human subjects are being exposed in the vicinity of a GE I-16 jet engine running at a speed of 15,000 rpm. Engines with greater thrust will be used later.

Animals as well as men are being used in the experiment. As a preliminary precaution, every step in the tests is tried out on animal subjects before the volunteers take their turns. Each of the nine men volunteering as subjects was carefully examined by a medical officer before the experiment began. Hearing tests, x-ray studies, and clinical laboratory tests were conducted. The subjects are provided with the best ear protection during their ordeal by noise.

It isn't the audible noise, however, that has given rise to the investigation. Rather, it's the unheard, the super-audio vibrations which cause concern. Everyone is familiar with the use of high-frequency dog whistles, the sound of which is beyond the range of the human ear but effective in calling Fido home. Are such vibrations, when emitted with tremendous intensity as the exhaust gases escape from the tail

pipe of a jet plane, dangerous to the human nervous system?

German scientists are reported to have been interested in these phenomena during the war, both as a problem confronting their jet plane personnel and as a possible offensive weapon, for they experimented with sirens planned to harass enemy ground troops.

Use of ultra-sonic vibrations as a fog dispersal method is one of the experimental projects of current interest to meteorologists and aviation personnel



NINE MEN DON HELMETS FOR EAR PROTECTION AT START OF JET VIBRATION MEDICAL STUDIES



# AFLOAT AND ASHORE

**NATS LANT**—With the help of 250 former transport pilots who came back on active duty from civilian life, two ferry squadrons were able to break a bottleneck of planes which had to be moved. VRF-2 had 102 Reserves to help move 221 planes and did the job without a single accident or damage to any plane. VRF-1 called back 148, most of them former ferry pilots.

**NATS PAC**—NATS played its part for anthropological research recently by flying 22 scientists to Guam to make a study of natives who had been under Japanese rule the past 25 years on Kusai, Truk, Kapingamarangi and Ponape. The scientists are attached to the Coordinated Investigation of Micronesian Anthropology project.

**VR-5, SEATTLE**—Alaskan duty isn't all drudgery. When the long-awaited salmon run started at Kodiak, NATS lay-over crews swarmed over the Baskin river and pulled many fine catches of silversides out of the water.

**VR-2, ALAMEDA**—The policy of flying a plane 10 hours locally after heavy maintenance is completed and prior to placing it in service pays dividends. After 6.6 hours on a newly-overhauled engine, the cylinder head temperature went beyond limits. Inspection showed the exhaust valve head ruptured.

**MCAS EL TORO**—All pilots of VMF323 have been assigned an aircraft and now assist the plane captains in checking and repairing of their planes, as well as in daily refueling and servicing. This not only relieves the personnel shortage, but also reduces maintenance. Pilots are prone to handle their aircraft more conservatively in flight.

**VR-6, PACIFIC**—The squadron has finished tying down its Quonset huts in prepa-

ration for the summer typhoon season. Experience has shown that the effort involved in preparing the buildings for typhoon security, arduous though it may be, is almost negligible in comparison to the job of replacing buildings and repairing damage after a storm has struck.

**NAS MOFFETT**—VR-4's "Junior Hot-shot," operating between Moffett and San Diego on Monday and Friday, has been operating with regularity approaching that of its big brother. This is the only NATS operation which is intrastate.

**MCAS EL TORO**—As part of the squadron training program, a photographic course is being given to all aviators in VMD 254. The training includes lectures and practical work in ground and aerial photography.

**NAS TILLAMOOK**—The station security officer who acts as game warden completed his portion of the facilities inventory as directed by the Assistant Secretary of the Naval Material division and reports the following: 17 deer, 5 covey of pheasants, 6 pair of mallard ducks, a brook full of trout and several pair of spruce grouse. He is undecided whether inventory cards should be made out now, as quite a gain by inventory can be expected in the next few months.

**MAG 33, El Toro**—VMF 323 recently made a notable improvement in survival gear. The new gadget consists of an elastic tape connecting the signalling mirror to the back of the dye marker packet. The elastic ribbon, two in. wide and six in. long, does not interfere with the use of either mirror or dye marker, yet it secures two loose pieces of gear.

**VRF-2**—Pilots of this NATS squadron carry a radio instruction booklet carrying

photostatic replicas of all types of control boxes ranging from obsolete models to the most modern. These booklets help in familiarizing them with gear found in their ferrying duties.

**VR-5, SEATTLE**—GCA proved its worth again recently, rescuing an Army B-25 which was trapped over Seattle with all fields below range minimums. Although he had gas to hold for a weather break, he was taking on ice and slowly losing altitude. GCA was called and promptly brought him down.

**NATSLANT**—VR-1 flights into the Caribbean area now are carrying baby food for Navy youngsters. Answering an urgent call from Guantanamo, 1200 pounds of strained food was flown in. Shipments for the kids had previously consisted of diapers. The thought occurs that having the diapers arrive first represents sound logistic planning.

**VR-5, SEATTLE**—The rapidity with which blowing fog can blanket a field was illustrated recently. Routine landings were made in two cases but the fog moved in so swiftly that the planes could not taxi unaided. "Follow me" vehicles had to guide them to the terminals.

**MCAS EL TORO**—MAG-25 flights to Guam and return which formerly took five days have been lengthened to eight days. Present schedule calls for RON's at Moffett Field, Honolulu, Kwajalein and Guam. Flights leave El Toro on Mondays and Thursdays.

**VP-MS-3, PACIFIC**—Seven planes recently ferried 84 officers and men and most of the squadron files across the Pacific to Kaneheo. Prior to the flight squadron personnel worked straight through the night in two shifts to complete an engine change. Total time was 31 hrs.

**VP-HL-13, PACIFIC**—This squadron recently inaugurated a monthly and quarterly employment schedule for the flight and ground training departments. Schedules are drawn up in poster form so that all personnel have finger-tip use of them.



The SC-2 Seahawk has successfully passed its rough water tests at Naval Air Test Center, Patuxent. The picture on the left shows the Seahawk on take-off and demonstrates its ability to operate in heavy seas. The center photograph shows what



happens when you try to turn the plane out of the wind in a 30-knot breeze. The picture on the right shows the plane is capable of landing under adverse water conditions. Results prove the SC-2 operates in 25-knot winds and five-foot waves.





CAG-1 HELLDIVERS OVER TINIAN; BASED ON SAIPAN IN FALL OF 1946, MANY NEW PILOTS THERE VIEWED THE EFFECTS OF WAR FOR THE FIRST TIME

# PEACETIME PILOTS



▲ AVENGER GETS THE "GO" SIGNAL ON THE FLIGHT DECK OF THE TARAWA  
▼ CORSAIRS AT KAHALUI, MAUI, WHERE FLYING WEATHER WAS EXCELLENT



CDR. SAM L. SILBER LANDS ON TARAWA FOR LAST TIME AT TOUR'S END ▲  
MANY AIR SHOW PATRONS VIEWED CAG-1'S SKILLED FORMATION FLYING ▼





AVENGERS "STACK THEM UP" FOR THE CAMERA

SINCE re-forming in May 1945, Carrier Air Group One, comprising VF-1A, VF-2A, VA-1A, and VA-2A, has gone through a two-year period of training and operations which succeeded in turning inexperienced personnel into squadron members well qualified for their exacting and varied jobs. With a turnover of between 300 and 400 percent, the reorganization problems was not easy.

CAG-1 is a well-traveled outfit. (See NANews, Feb., p. 18) Those aboard since the re-forming have been across the United States, down to the Caribbean twice, through the Canal, half way around the world and back. From May 1945 to May 1947 about 500 days were shore-based and 200 days ship-based. Of the latter, approximately 80 days were spent operating, using the following carriers: *Croatan*, *Guadalcanal*, *Tarawa*, *Salerno Bay*, *Boxer*, *Princeton*, and *Bairoko*.

In the Pacific area the Group participated in Fleet battle problems. Between cruises, life on Saipan gave a satisfying blend of bombing and gunnery practice (See NANews, June, p. 8) with lighter moments of relaxation (NANews, March, p. 20).

Flight time statistics show that the Group had a total of 62,604.6 hours, VF-1A being high with 21,500 hours. Pilots made 8,005 carrier landings and were shot off the catapult 1,246 times. Average landing interval was 37.5 seconds; VF-1A's average was 33 seconds. CAG-1's best time was established during a battle problem near Tsingtao, China, when a 58-plane flight was landed in 29 minutes.

The enthusiasm of CAG-1 personnel has been reflected in the frequency of their communications to NANews. Other outfits undoubtedly have interesting reports and pictures which should be submitted for the record.

## Marine Pilot Dodges Chinese Bullets

ONE OF VMF-218's *Corsair* pilots has a very interesting "sea story" to tell back home—all about how he landed in a Chinese No-Man's-Land between fighting Nationalist and Communist troops and came out unscathed.

While on a routine railroad patrol, the F4U-4 experienced engine failure in a rather inaccessible spot near Tang Shan on the Tientsin-Chingwangtao railroad. He made a wheels-up landing in a field, seriously damaging the aircraft. The pilot emerged unhurt, except for a stiff neck, to find himself between two actively engaged forces contesting custody of the aircraft.



Immediately reasoning that troops nearest the railroad were more likely to be Nationalist, he ran towards them. These people seemed quite friendly, but the *Pointie-Talkie*, an Army publication issued to provide communication between English-speaking and Chinese-speaking peoples, proved ineffective in determining their political sympathies.

Also, being originally intended for grounds troops, it made no reference to aircraft or its equipment and was therefore useless in requesting assistance in salvage, providing guards, etc. In addition, it was originally made up for Army personnel and provided no means for a Marine to establish communications with his parent unit.

In this particular case, however, the pilot was fortunate in that his assumption had been correct as to which were Nationalist troops (as was later established by an English-speaking interpreter), and his section leader was able to establish radio control with a Marine unit at Tientsin which dispatched OY's to the scene of the crash and later brought in salvage crews.

The Nationalist troops drove the attacking Communist troops away from

the aircraft and maintained an adequate guard on the aircraft until arrival of a Marine platoon from Tangku.

In the case of personal survival, the M-456B electrically heated winter suit, worn over normal clothing, was quite adequate defense against the elements, although the pilot was exposed for several hours trying to make himself understood, while waiting for arrival of Marine guards, and during a six-mile donkey ride to reach an interpreter.

## Navy Gets Its Last Mariner

THE NAVY has bought its last PBM flying boat. After purchasing 1329 of the big lumbering patrol planes, the Navy closed the book on them when it took delivery on a PBM-5G No. 1308.

The design started in the late 30's before hostilities broke out in Europe. A number of PBM-1 aircraft were delivered before the invasion of Poland. Need for a larger and faster plane brought on the PMB-3, which was in production before Pearl Harbor. The Navy received 679 of this model and followed up with 529 of the PBM-5's.

There is an order still in effect with Glenn L. Martin Aircraft Corp., for 24 of the amphibious versions of the *Mariner*, the PBM-5A. It is expected this plane will find its main use in search-and-rescue work. Main landing wheels on the boat hull fold 180 degrees upward into wells in the hull and the nose wheel retracts into a forward bay.

Navy pilots for the most part learned to fly the big *Mariner* at NAS BANANA RIVER. Although slow and heavy, it saw plenty of service all over the Pacific during the war. The *Mariner* was the Navy's largest combat seaplane, although the *Coronado* had four engines to the PBM's two. The Martin *Mars*, a larger plane, was solely a transport. The original *Mars* and its sister planes are twice as heavy as a PBM and have double the range.



NAVY TO BUY 24 AMPHIBIOUS VERSIONS OF PBM

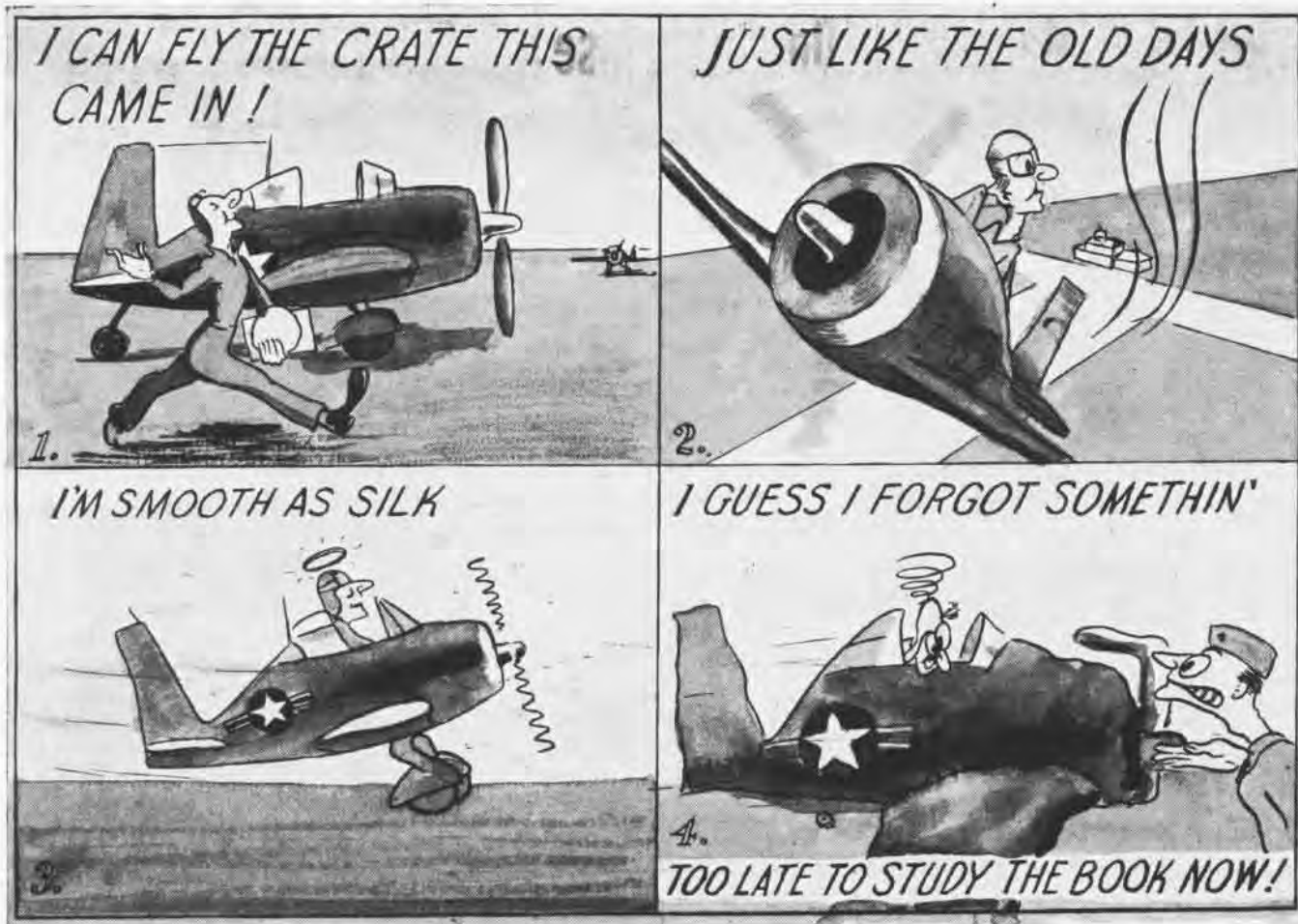

## LT. CDR. N. O. ITALL.

### Moral: Know the Airplane You Fly

IT HAPPENS all too frequently that even some of the high time pilots get themselves in a jam by thinking that they have the word on flying any airplane, particularly the trainer they knew so well. You'd be surprised what you've forgotten—even the simple things that can get you in so much trouble. In this respect see *Manual of BuAer Article 6-101* for instructions regarding flights in aircraft and review the *Pilot's Handbook of Flight Operating Instructions* for the type plane you intend to fly and maybe haven't flown for a long time. Insure that you get a thorough cockpit check-out. An airplane is a very expensive item and so is your neck.

**CASE I.** A pilot of an F6F-5 (with only 4.1 total hours in type) returning from a section tactics flight began some unauthorized aerobatics. During a slow roll the plane fell out while on its back, went into a high speed stall and crashed. The pilot was killed. It was determined that this accident was caused by the pilot in not applying the proper recovery technique and in attempting aerobatics before becoming familiar with the plane.

**CASE II.** A pilot of an SNJ returned from a local famil-

iarization flight and made a normal entry into the landing pattern, extended his wheels, then retracted them in his final approach. The tower visually checked that the wheels were extended when the airplane was about a half a mile from the field, then failed to notice that he retracted the wheels soon thereafter. So, the pilot made a wheels-up landing. The passenger, an aviation mechanic, heard the warning horn blowing yet failed to inform the pilot. The aircraft accident board determined that the pilot had retracted his landing gear instead of lowering his flaps and that he did not exercise proper care in manipulating the actuating levers. He was not familiar with the airplane.

**CASE III.** The pilot of an SNB-1 was returning to the airfield and discovered that the wheels would not lower after placing the landing gear switch in the down position. The circuit breaker switch was operated several times but with no results. An attempt was made to lower the wheels manually but as the landing gear clutch pedal had not been depressed—no results. Again the circuit breaker and the electric switch were operated—no results. Finally, the landing gear clutch was depressed and the wheels dropped.

A visual check that both wheels were down was made and then the plane was landed. Three hundred yards after turning off the runway, the wheels collapsed and the plane nosed up. It was the opinion of the aircraft accident board that due to the pilot's lack of knowledge of the correct emergency procedure, the wheels were not properly lowered and locked. With the landing gear switch to the down position the wheels dropped when the clutch pedal was depressed and the pilot took it for granted that the wheels were locked down and neglected to use the hand crank to fully extend and lock them. Result—considerable damage.



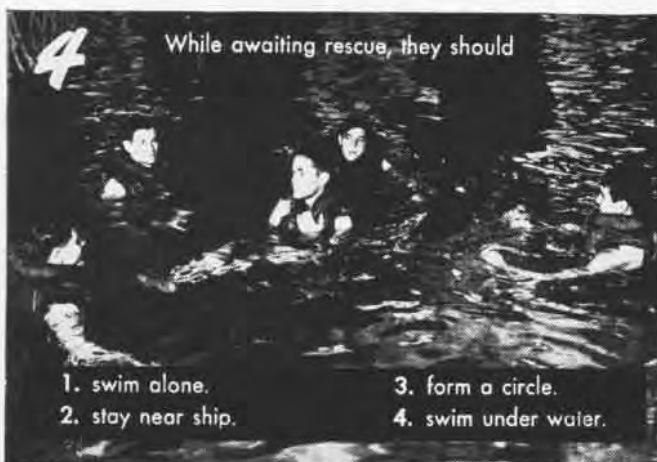
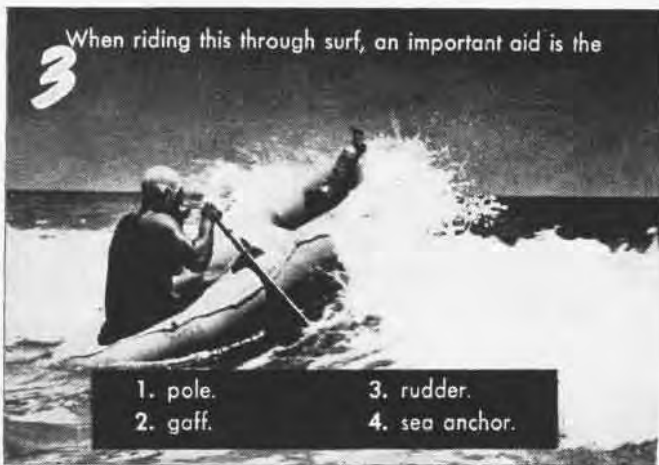
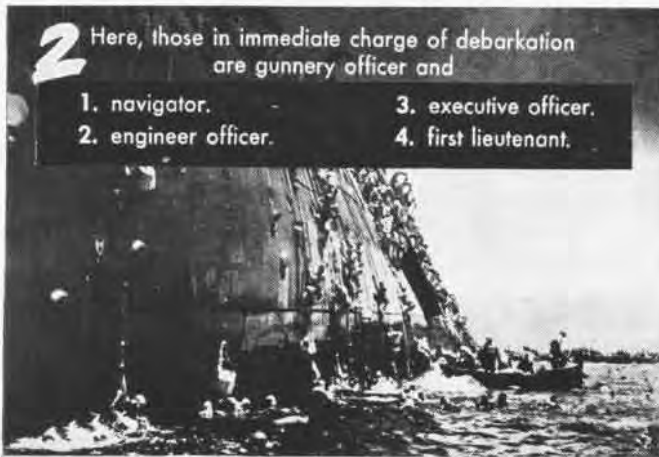
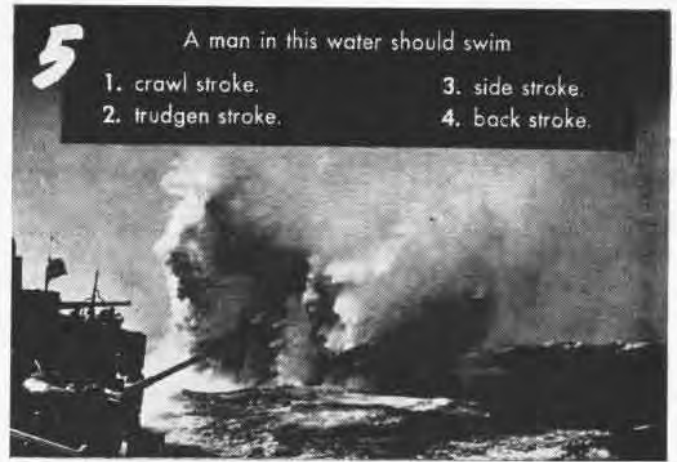

# Test Yourself

on

## Survival at Sea

1 \_\_\_\_\_ 4 \_\_\_\_\_  
2 \_\_\_\_\_ 5 \_\_\_\_\_  
3 \_\_\_\_\_ 6 \_\_\_\_\_

# RALLY ROUND THE STANDARDS



CALL A SPADE a spade, and the chances are that the corner hardware store won't have more than two or three to show you. But when it comes to the nuts and bolts and screws that an aircraft mechanic tries to get from the storekeeper, it's different. "Gimme a screw to go in this gizmo."

"What screw do you want? We've got 15,950 different kinds." That's it—15,950 different screws are manufactured for aircraft use. Of these, 5,251 varieties come under Navy standard stock numbers, and about 10,700 more are identified by manufacturers' proprietary numbers. Somehow the mechs who use them and the supply departments which stock them are expected to keep them straight.

Even the worst nightmares of a mail order house shipping clerk can't match the headaches of this business. Coming back to the screws—if you have 15,950 varieties of screws, you need special screwdrivers too. Maybe not 15,000 but still a tremendous range of corresponding tools has to be provided. It's a vicious circle, typical of problems all through the supply and maintenance systems for naval aircraft.

During the war there was little chance to remedy the situation. But on 8 May 1947, action began. The Joint Army-Navy-Industry (JANI) Standardization and Simplification Conference, called on that date at ASO PHILADELPHIA, tackled the problem. As a result of that conference a pamphlet has been issued for wide circulation to engineers and others in the Aircraft Industry concerned with designing and constructing the airplanes procured by

the Armed Services for future use.

In the pamphlet's "Foreword" signed jointly by Lt. Gen. Ira C. Eaker, USA, and Vice Adm. D. B. Duncan, USN, the objective of the JANI conference is stated as follows: "... to discuss ways and means of improving the operating availability of Army-Navy aircraft through further simplifying materials and processes used in airframe construction—an objective which can be greatly advanced through greater use of AN standard materials with a corresponding reduction in the use of 'manufacturer's standards.'"

Groundcrewmembers will want to stand up and cheer at the prospects of streamlined supply and maintenance, for it's the field maintenance men and the overhaul shop personnel, the mechanics and storekeepers who will be helped.

FOR SPECIFIC examples, come back to the screws. Thorough investigation by aeronautical engineering, maintenance, and supply specialists showed that the Navy stock quantity of 5,251 could be reduced to about 1,000 different kinds for future procurement and use. What's more, those other 10,700 varieties of screws, listed mainly under the drawing numbers of the manufacturers of airframes and associated equipment, could be replaced in maintenance and overhaul by that first 1,000. From 15,000 to 1,000!

How did the number ever get up to 15,000 screws in the first place? Here are some of the answers:

1. Personal preferences of the designer, coupled with the "Rube Goldberg" tendencies of drafting board men.
2. Personal preferences of users.



3. Failure on the part of the industry to standardize, plus a tendency, for merchandising reasons, to pander to the prejudices of customers.

4. Stockkeeping and stock identification errors.

5. Laxity in inspection and enforcement by both industry and services.

6. A generally apathetic attitude of "what's the difference."

Studies of bolts, bearings, clamps, fittings, gasket material, hose assemblies, pins, rivets, sheet, extrusions of all sorts, showed the same situation; and the lists are still growing. In rivets, for example, the Navy will procure fewer than 500 different kinds in the future; present stocks include 3,300.

The machinery for effective standardization has long been set up—it's nothing new. Army-Navy Aeronautical Standards (the familiar AN of part numbers) are the responsibility of WCAB, the Working Committee of the Aeronautical Board. Its specifications, drawings, and bulletins may be compared to the legislative acts of Congress; while the execution is delegated to others, viz. to the Commanding General, AMC, and the Chief, BuAER.

The point pounded home at the JANI conference is to have those standardized items, materials, and dimensions *more exclusively used* and to *avoid use* of "company standards."

The second point is to *cut down on the range and variety of items* incorporated in any one airplane. Discourage the airplane manufacturer from using 600 different kinds of bolts in one airplane—even though all might be AN standard bolts—since a variety of only 100, or even less, usually will more satisfactorily serve the purpose.

It was to be expected that during the war the aeronautical stock lists of the Armed Forces would increase at a

tremendous rate because of accelerated design progress, material shortages and substitutions, with consequent relaxing of requirements of AN specifications.

But since the end of the war there has been no observable decrease in this trend. Added emphasis on research and development has been the cause. Efforts to pare down the Army-Navy stock lists have been offset by the introduction of new items growing out of the needs of higher speed aircraft, jet and rocket propulsion, and similar revolutionary new developments, requiring higher strength, closer tolerance, new materials and processes.

**A**DDITIONAL AN standards can be created to cover new needs and new materials, with duplication eliminated, and the deadwood cut out of existing specifications. Members of the airframe industry responsible for purchase of materials needed by their fabricating shops, and those responsible for production output have similar views to those of the Army and Navy—viz. reduce and simplify.

It took approximately 42 months for the aircraft industry to reach peak production—the "victory level"—during the war. As speakers at the JANI conference emphasized, such a time lag would be disastrous in another emergency. The use of standardized materials, a heavy factor in production speed, would be of vital importance to national security in case of another war. And the standards must be adopted now.

As an example of what can be done in the way of simplified design, it was pointed out that the fin of a wartime fighter, produced in large volume, has been re-designed to reduce the component parts from 90 to 25. This cut the cost of the airfoil from about \$300 each to \$60 each. Had this new design

been used in the mass production of the plane, a probable saving of 2,000,000 man-hours could have been made.

On the other side of the ledger are such problems as the maintenance burden developing with the relatively new high pressure hydraulic system, usually known as the 3,000-pound system. While it actually has been used in one or more models of aircraft for about four years, there is still no sound plan or effort toward standardization and simplification of its components. Why can't actuating cylinders, for example, be standardized in six or eight diameters, thus vastly easing the problem of maintenance and supply in connection with the gaskets, rings, packings, and other consumable items.

Man-hours saved, money saved, production and maintenance efficiency increased—it all sounds rather dull and far removed from the activity of operational flying. But shift the scene to an island airstrip being bombed and strafed or to the deck of a carrier in action. Here it is that the "miracles of maintenance" happen.

A quick engine change made, a burned-out exhaust unit replaced, a new starter installed—the planes must be put back in fighting condition. Minutes mean lives. There's a big gap between the design engineer looking over his blueprints and the squadron mechs racing against time, under primitive working conditions, to get badly needed planes into the air. The JANI conferees intend to bridge that gap.

Availability is what counts. And availability means spare parts on hand, standard parts, standard tools to do the work. It means a supply line flowing smoothly, not dammed up by the debris of unnecessary, non-standard stocks. The hottest pilot might as well be "Dilbert" if his plane is grounded.





BEACHING P-BOATS IS NOT NAVY'S MOST ROMANTIC DUTY BUT A PLACE WHERE TEAMWORK PAYS

## BEACHING BIG BOATS

VP-MS-2, SAN DIEGO—This squadron believes it has one of the most efficient systems in the Navy for launching and beaching seaplanes. More planes are launched and beached by this command each day than any except the training commands at Pensacola and Jacksonville.

The method used insures speed in operation as well as safety for the plane. Although lines have parted during launching and beaching operations, no aircraft ever has been damaged since the squadron began in 1 October 1946.

Beach crew duty is considered choice duty by its members; therefore, men are not assigned to the beach crew for disciplinary reasons. The crew is under charge of two aviation chief boatswain

mate plane handlers who alternate between morning and afternoon operations.

The regular beach crew under normal operations can beach a seaplane within six minutes of the time it secures to the buoy in front of the ramp. Launching as a rule takes a minute less but it is more or less governed by whether the pilot of the plane is ready to be launched. On one occasion, the duty section launched nine PBM's in a record of 56 minutes. These men were not considered experienced either.

A report on the system used by the squadron is being submitted to COMNATSLant, which is interested in standardized beaching procedures for the Navy.

### Wrench Removes Spark Plug

NAS ANACOSTIA—A marine sergeant attached to the Marine Air Reserve Training Unit here has designed a wrench to remove the threaded portion of a broken 18 mm. spark plug. No drilling is required prior to tapping as the hole remaining after removal of the core is about tap drill size.

To use, tap out threaded portion of plug with a 1/2" 20-thread tap, left hand.



Broken piece occasionally will come out during the tapping process. After tapping, insert the wrench, turning it to the left. When the wrench seats itself on the broken plug, further turning will unscrew the plug from the cylinder.

(Devised by Sgt. John Hrin)

### Wringer Helps Seams Work

NAS COCO SOLO—A&R structures division devised a machine to assist in making water-tight seams on PBM hulls. This operation formerly was performed by hand and entailed a waste of man-hours and zinc chromate compound.

The machine devised for this process is built on the principle of a clothes wringer. Flannel is drawn through the compound and passed through the rollers, squeezing the compound into the fabric. Excess compound remains in the wringer. The new process reduces consumption of man-hours and materials, and eliminates the unpleasantness of the operation.

### Speed Chute Idea Tried Out

How to save the life of the jet plane pilot who has to bail out at relatively high speeds is one of the unsolved problems of the Navy thus far but any idea that sounds worthwhile is being tried out.

When NANews dealt with the problem in "Jet Pilot Safety," June issue, it received a letter from Lt. (jg) F. J. Brauer on the U.S.S. *Midway* outlining his idea of a chute which might slow the pilot down so that he could use his regular chute without too great an opening shock.

Brauer's idea, illustrated here, was turned over to BUAE Airborne Equipment section which sent it to the Parachute Experimental Unit at Lakehurst for test. A model was made and tested both by wind machine and drop in protected air inside the unit's former blimp hangar.

The report stated that "the model

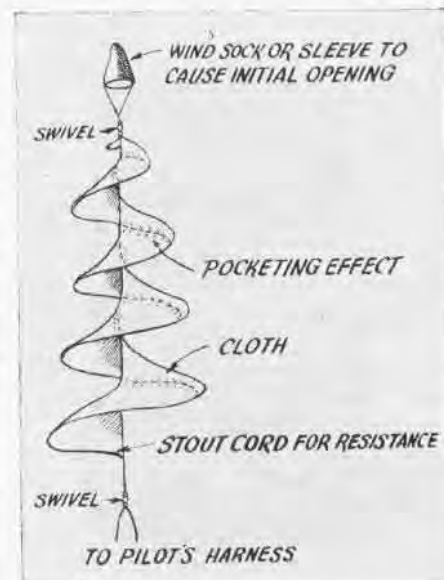

failed to inflate and acted as an extreme minimum of drag. The fabric area shown for 'pocketing effect' did not inflate but streamed out along the central cord in a jumbled mass."

Another test will be made with the model to see if it would work better if dropped with the small end of the chute down instead of at the top, as illustrated. BUAE welcomes ideas from personnel in operational units which might help solve the pilot safety problem. It still is looking for ideas on aircraft carrier barriers that are suitable for several new jet plane designs.

VR-5, SEATTLE—Two very soft landings were made by NATS transports at Fairbanks, Alaska, recently, for a very good reason—more than 9,000 pounds of gelatin dynamite was aboard each flight.



# LETTERS



SIRS:

The Navy's FD-1 *Phantom*, first all-jet carrier fighter plane, makes a good backdrop for Jacquie Phillips, recently elected Sky Belle at McDonnell Aircraft Corp., of St. Louis. This study in aerodynamic and feminine streamlining features the prize-winning model of the *Phantom*, made by a company employee.

Laminated from sections of blue plexiglas, the model was sawed out, shaped with a Vixen file and polished on a buffing wheel. The smooth finish of polished plexiglas is a good copy of the finish on the *Phantom*.

PUBLIC RELATIONS DIVISION,  
MCDONNELL AIRCRAFT CORP.



SIRS:

At last the man who answered the \$64 question has been located. He is Glen G. WALKER, ARM2C, stationkeeper in the Communications Dept. at NAS Los ALAMITOS. The broad smile in the photograph would make one assume that his being found out didn't make him feel too badly.

Glen was able to answer all questions up to and including the \$64 question, in addition, went right on to answer the question winning the jackpot of \$901 at the Phil Baker "Take It Or Leave It" show, which was broadcast from the station auditorium over NBC, Sunday 29 June, 1947. The show wound up the



**It may** look like St. Elmo's fire, but it's really lucite installed on wing tips, rudder and elevators by Aero Medical Equipment Laboratory, NAMC Philadelphia, to find the best kind of exterior lighting for night-flying planes. Pilots often get confused by ground lights, stars or similar single lights and fly into each other or into the ground. The Lab also is studying employment of flashing lights like commercial planes install.



SIRS:

We have viewed admiringly those pictures of the big trains sailing majestically over all types of sea and terrain, the utility craft hopping about within their respective domains; the 'boats in mud, dust, and sea; and the speedballs with little else for background but a swish.

We submit herewith what we believe to be something a bit different and that of which we are immodestly proud: VP-HL-12 in formation near Mt. Baker, Washington.

CDB. L. R. JENSEN  
COMMANDING OFFICER



Open House celebrating the first anniversary of the Naval Air Reserve.

E. C. INGRAHAM, LT. CDL.  
PUBLIC INFORMATION OFFICER  
NAS LOS ALAMITOS



NAS TILLAMOOK—The air station's Public Works chief quarterman aided in saving the life of an electrocuted power company lineman recently. While working on high tension lines, the man stepped on an 11,000-volt wire. Power immediately was grounded out and the man removed from the pole. A call for assistance was made to the quarterman, who resided nearby, and he applied artificial resuscitation until relieved by a local physician.



SIRS:

In the Thirteenth Naval District Boxing Tournament held at this station, Alfred Mungia, Seattle, and Wilson Waters, NAS TONGUE POINT, inspired spectators by scoring a double knockdown in the third. Waters decked Mungia in the first. He took the count and came back to score a knock down in the second over Waters. The double knock-down in the third resulted in Mungias taking an official count of four and Waters, failing to respond, was counted out.

James Minter, Seattle lightweight, Lester Kubec, Seattle NARTU flyweight, W. McCoy, NAS ASTORIA bantamweight, Featherweight John O'Connor, NAS WHIDBEY ISLAND and Jim Humphrey, Columbia River Group heavyweight were named district champs.

N. J. GOELTZ, LT.  
NAS SEATTLE

# LETTERS

SIRS:

Ex Patrol Bombing Squadron 128, a wartime Navy squadron of *Venturas*, is maintaining the spirit and camaraderie developed during its wartime combat duties. A continuous interchange of correspondence among its pilots and the publishing of a periodical "dope-sheet" by the original ACI officer containing the status, address and personal sketches of its members has kept the Squadron "alive" since its decommissioning in the Pacific area shortly after VJ day.

The first annual reunion of the squadron was held on the weekend of 27-29 June, 1947. The inaugural dinner and meeting took place at the Officers' Club at Floyd Bennett Field, New York. A large turnout, journeying by plane, train, car and thumb, came from about every section of the U. S. and the weekend was filled with reminiscences, new stories and a unanimous vow to keep the old squadron spirit of "all for one and one for all" red hot through the years to come and support Naval Aviation and the Naval Reserve to the utmost.

A souvenir booklet containing the squadron's wartime history, liberally interspersed with photographs and humorous anecdotes, is being prepared for distribution to all the Squadron.

C. L. WESTHOFEN, CAPT., USN  
FIRST C.O. OF VPB-128  
USNA, ANNAPOLIS.

SIRS:

On Page 19 of the May issue of NAVAL AVIATION NEWS, you printed a photo of a NARTU SEATTLE pilot hanging on the side of an SNJ. In this photo we noticed three interesting details.

1. The pilot has broken the "tacking" of his parachute lift webs because he is allowing the pack weight to be borne by the lift webs, instead of leaving the pack in the cockpit of the ship. (One of the designed purposes of the QAS parachute.)

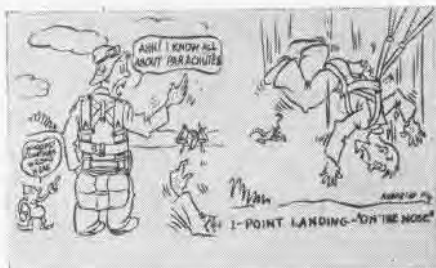

2. With his riser snaps hooked up to the lift webs, as shown, he will hang upside down when he pulls the ripcord in a bailout. Both snaps are hooked up inside his sling.

3. Obviously, he hasn't read T.O. No. 74-44 regarding the QAS chute.

E. L. FEELY, CPT  
W. R. VOLLENWEIDER, PR3C  
S. B. CARY, PR2C

NATTC JACKSONVILLE

¶ BUAE's Parachute section concurs in your opinion that the Seattle pilot, Lloyd L. Owens, would have a rough ride with his chute attached as it was in the photo.



SIRS:

Your West Coast bearings on "Lost in the Flatlands" make you a "Dilbert" for the month of July and NANews eligible for a scolding by old *Grampa Pettibone*.

I find your quizzes very enjoyable and educational, and are I believe, the highlight of your magazine. But whether the Bay Area fog smoked up your glasses, or the Gremlins switched plates before you went to press, I'm sure any West Coast "Zoomie" will agree that NAS MOFFETT FIELD is not the top plate as stated on page forty of your Air Stations Quiz. Moffett is a very close allied neighbor of us here at NAS ALAMEDA, as their NATS and blimp hangars are a landmark hereabouts. Even *Dilbert* knows that.

I'm sure that you'll receive an avalanche of mail squaring you away on the Air Station Quiz Snafu. But constructive criticism is always welcome in aviation and I know that NANews will remain to rate 4.0 as the spokesman for Naval Aviation. I'll take this opportunity to thank you for your 4.0 magazine even though I'm sure *Dilbert* is laughing up his sleeve at NANews.

PATRICK C. SHANAHAN, AM2  
NAS ALAMEDA.

¶ After digging our way out of the avalanche of letters calling us on our mistake in the Air Station quiz, we hereby acknowledge the top picture on our July inside cover is Inyokern and the bottom one Moffett. Somebody switched cuts on us, honest.



The Cover. Three men and a 'Beast' might be the title of this unusual carrier landing shot. The LSO, his assistant and a third 'observer,' all intent on bringing in the SB2C, were aboard the *Essex* during one of her many cruises in the Japanese war zone.

## CONTENTS

Flying Pinwheels	1
Grampaw Pettibone	6
Did You Know	8
NANews Visits	11
Reserve Flying	14
Dark Shark	16
SNJ Trainer	17
Jet Hotfoot	18
Jet Vibrations	22
Peacetime Pilots	24
Flight Safety	26
Rally Round	28
Beaching Big Boats	30

\* \* \*

And There I Was 20, Afloat and Ashore 23, Technically Speaking 27, Service Test 29, Wing Tips 34, Aviation Progress 35, Aviation Ordnance 36, The Howler 37, Publications 38, Letters 39-40.

## ANSWERS TO QUIZZES

### • RECOGNITION QUIZ

(inside back cover)

1. FB-49
2. Lavochin jet (Russian)
3. F6U Pirate
4. P-84 Thunderjet
5. P-80A Shooting Star
6. FD-1 Phantom.

### • AIR STATION QUIZ

(inside front cover)

Top—NAS Dallas, Tex. Bottom—NAS Chica, Fla.

### • SURVIVAL QUIZ (pg. 27)

- 1-3, 2-4, 3-4, 4-3, 5-4, 6-4

NAVAL AVIATION  
**NEWS**

Published monthly by Chief of Naval Operations (Op-50-D) and Bureau of Aeronautics to disseminate safety, survival, maintenance and technical data. Air mail should be used if practicable, address to: Chief of Naval Operations, Naval Aviation News, Navy Department, Washington 25, D. C. Direct communication can be made to Naval Aviation News, Room 4927, Main Navy Bldg., office telephone extension 61662.



# Sky Scorchers

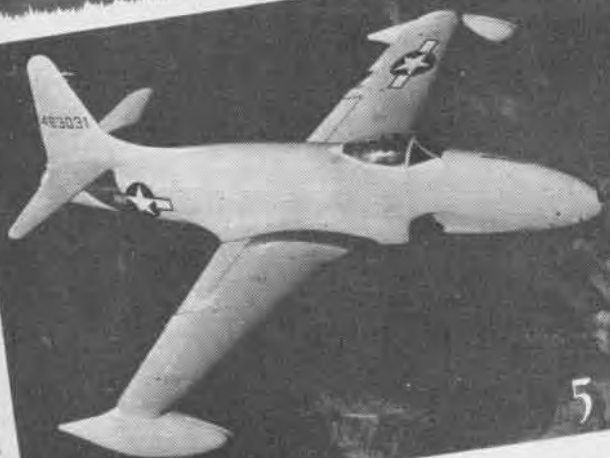
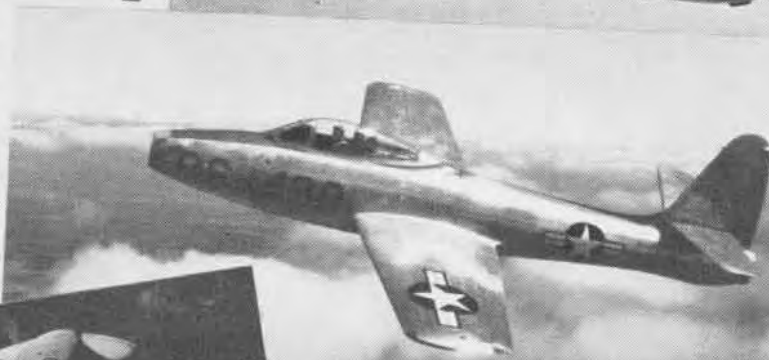

*answers on opposite page*

NAVAL AVIATION  
**NEWS**

# PUT \$2 ON N.A. NEWS

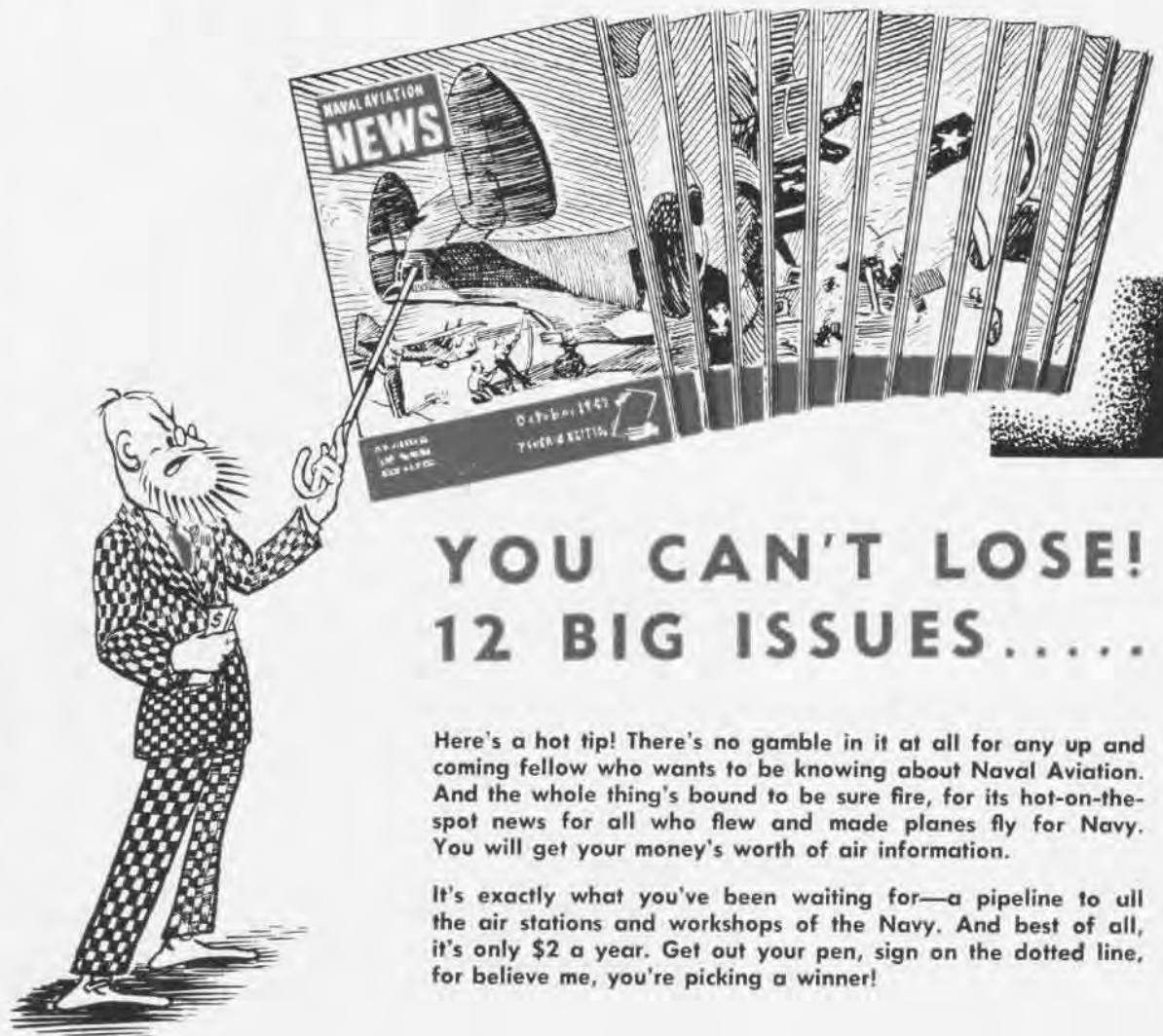

## YOU CAN'T LOSE! 12 BIG ISSUES.....

Here's a hot tip! There's no gamble in it at all for any up and coming fellow who wants to be knowing about Naval Aviation. And the whole thing's bound to be sure fire, for its hot-on-the-spot news for all who flew and made planes fly for Navy. You will get your money's worth of air information.

It's exactly what you've been waiting for—a pipeline to all the air stations and workshops of the Navy. And best of all, it's only \$2 a year. Get out your pen, sign on the dotted line, for believe me, you're picking a winner!

SUPERINTENDENT OF DOCUMENTS  
GOVERNMENT PRINTING OFFICE  
WASHINGTON 25, D. C.

PLEASE SEND ME THE NAVAL AVIATION NEWS FOR ONE YEAR. ENCLOSED  
IS A CHECK (OR MONEY ORDER) FOR \$2.00.

NAME .....

ADDRESS .....

CITY ..... ZONE ..... STATE .....

**MAIL THIS  
TODAY**