

BUAER
News Letter



Training Literature
Room 4822



C O N T E N T S

This Pamphlet Will Be Destroyed
When It Has Served Its Purpose

Naval Aircraft Factory	2
Flight Statistics	5
Did You Know?.	12
Fleet Aircraft	19
Training	23
Shore Stations	33
Overheard	38
Technically Speaking	48
Air Warfare Diary.	55





NAVAL AIRCRAFT FACTORY

Perhaps the least-known and most interesting aeronautical plant in the United States is the Naval Aircraft Factory, situated at the Philadelphia Navy Yard. The only organization of its kind, it differs from privately operated plane factories in that it is virtually self-sufficient, manufacturing on the spot nearly everything that goes into a Navy plane.

Not only does the Naval Aircraft Factory manufacture Navy planes, but it also fabricates many parachutes and tow targets, tests aircraft manufactured by other concerns, conducts

secret development and research programs on everything from pressure chambers to aircraft paint, and does a lot of the "dirty" production work shunned by commercial Navy contractors.

Most other so-called aircraft manufacturers in the U.S. are actually in the business of making and assembling airframes. Engines, propellers, landing gear, radio, instruments, and scores of other items necessary in a modern fighting craft are usually "Government Furnished Equipment," having come off assembly lines scattered throughout the country.

At Philadelphia, NAF's Capt. W.W. Webster manages an organization which has approached the point of self-sufficiency in aircraft production more closely than any other known establishment.

The factory's production department has its own well-rounded line of aeronautic equipment consisting of airframes, wing assemblies, powerplants, propellers, plastic-plywood assemblies,

The first unit of this project was launched in October 1942 and output has been showing favorable gains each month. Known as the "Nomad," the PBN is a Naval Aircraft Factory issue of Consolidated's PBY Catalina.

Many other production jobs are of a confidential nature, but it can be said that considerable experimentation and output is being marked up in the realm of plastic-plywood planes

Virtually Self-Sufficient, NAF Manufactures nearly Everything that goes into a Navy Plane



parachutes, tow targets, and some radio and instrument parts.

In addition, the powerplant shop performs extensive overhaul and rebuilding operations on aircraft engines withdrawn from service after gruelling combat and patrol duty. These revitalized engines leave the Philadelphia shop with all worn parts replaced, testifying to the careful inspection necessary to assure fitness for flight.

ACTIVITY

Activity at NAF is divided about equally between production and development. One of the biggest production jobs at present is the PBN contract.

and sub-assemblies.

The last issue of the NEWS LETTER told of NAF's amphibious glider which is built of moulded plywood and other nonstrategic materials. Additional glider plans are in the works, and the sky above Mustin Field, which adjoins the factory, is frequently dotted with powerless craft circling for landings.

Responsibility for the manufacture and repair of parachutes and tow targets is held by the fabric shop. The experimentation carried on at NAF in connection with parachute manufacture has effected a reduction in

cost of the chutes from \$700 to \$100 each.

The factory's pressure chamber, details of which are closely guarded, is designed for testing both human beings and materials. A project of NAF's engineering department, this chamber simulates altitudes up to 70,000 feet and temperatures down to minus 120 degrees.

WORK-SUGGESTION PLAN

Like many other war production plants, NAF's worker-suggestion plan has brought forth many useful ideas

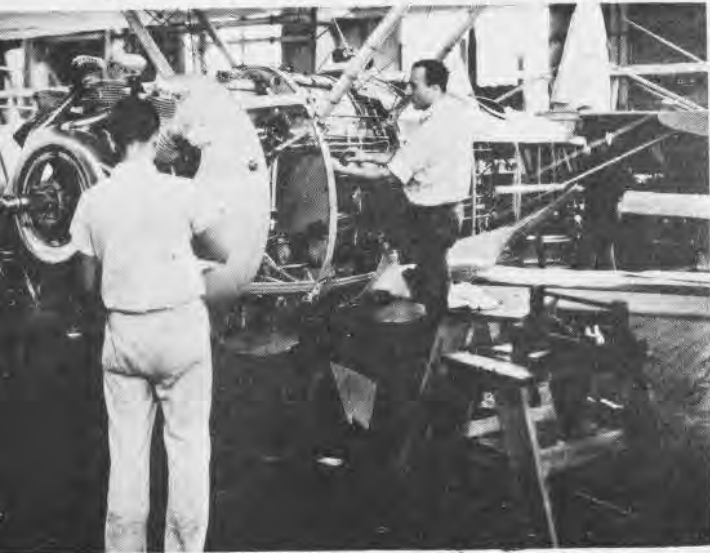

which have been adopted to provide short-cuts in production. Cash awards granted for new ideas range from \$100 for a pilot parachute frame design to \$17 for the design of a stamp to be imprinted on the back of rejection tags showing a grinning Jap saying: "Mistakes make so happy, thank you." The suggestion board a few months ago paid \$5 to a clerk who suggested that black-out windows be given a basic coat of white paint.

Some idea of the present rate of expansion in the factory's production department can be seen in a comparison of the numbers of workers in training versus workers "on the line." Total employment in the production shop is 5,680. Various types of trainees--apprentices, mechanic learners, instructors and others--total 2,112. At the end of their training period, these

new employees will join the growing force at NAF which has now reached 11,500 in all departments. The factory is divided into supply, engineering, production, accounting, inspection, plant, and flight departments.

Not a few of NAF's employees are women. The factory's personnel office is proud of the fact that 40% of the production hands are females, with more signing in every day.

One of the supervisors says the women do everything the men ever did and do it neater. "Only the other day," he said "a girl who works in one of our shops was riding on a street car from the Yard chewing her tobacco like a lady."

The management is endeavoring to protect the female contingent by safety orders as to clothing, and the increasing use of turbans for hair protection around machines is noticed in all shops. Some of this precaution was prompted by an occurrence at one of the shops wherein one of the young male employees with a flowing head of hair was partly scalped by a machine. The word got around.

Soon, at another nearby Navy Yard, the following notice was posted: "Male employees may wear their hair beyond usual length without being in conflict with safety regulations, if the hair is adequately held in hair nets. These nets need not exactly match the natural hair in color or texture."



"WHAT'S COOKIN'?"

Others would like to know about your activities. Tell News Letter and you tell them.

FLIGHT STATISTICS

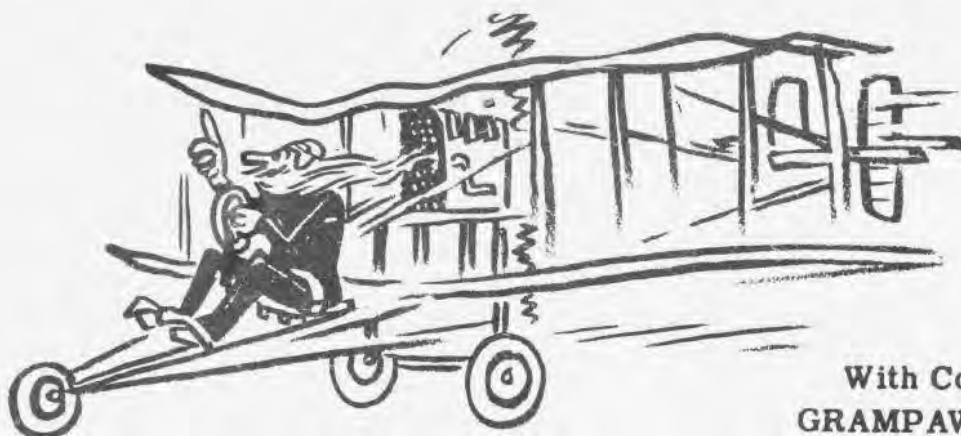

With Comments by
GRAMPAW PETTIBONE

FLIGHT TRAINING SAFETY RECORD:- Flight statistics for the first quarter, fiscal year 1943, have just been compiled. Particularly noteworthy is the figure on the crashes per thousand hours of flight training; this is not only better than recent comparable rates, but is the lowest crash rate in the entire history of naval aviation.

The fact that this record was attained under the press of wartime acceleration and expansion makes it all the more heartening. (Suitable purple adjectives fail us.)

All concerned are to be commended.

Grampaw Pettibone says: Now don't get cocky! That's what goeth before a crash.

And don't start easing up; the records also show that 76% of the fatalities in flight training occurred as the result of pilot error and, therefore, were avoidable. Until we cut down on this pilot error there really isn't much to cheer about. So take another hitch in your belt and intensify the vigilance and pressure.

CAUGHT SHORT! -- While accompanying a nine-plane formation of student pilots on a practice navigation flight over water, an instructor allowed himself to be caught short. The leading student made an error in his navi-

gation problem and took the group too far out to sea. The instructor apparently just went along for the ride and did not work the problem, as he should have done. It was not until on the return leg that he realized there had been a serious mistake. Having insufficient fuel to return to base, he decided to land on the beach, where the airplane nosed up and suffered major damage. The students, flying planes with a longer range, were able to return to base - that is, all except one, who also made a crash landing.

AVIATOR'S FLIGHT LOGS:- Air Transport Squadron VR-3 has requested authority to use the column headed "Passengers" in subject logs to record aviator's instrument flight time and night flight time. Since these logs are maintained chiefly for the benefit of the pilots and squadrons concerned, there was no objection to this change and authority was granted. This information is published in case other squadrons may desire to maintain pilot flight time in a similar manner.

"SIMULATED EMERGENCY" ACCIDENTS:- Case 1. A simulated emergency was given in which the aircraft was allowed to descend to such a low altitude that when recovery was attempted the aircraft

TODAY, DILBERT, WE'LL
HAVE SOME SIMULATED
EMERGENCIES.



struck high tension wires at the end of the clearing.

From student's statement: "My instructor was instructing me on slips and proceeded to demonstrate same in a small clearing near the river. After slipping as low as safety would allow, he gave it throttle and started out. I did not see the post or wires until we hit and do not think the instructor did either."

Case 2. During simulated emergency procedure, the airplane was permitted to glide to a very low altitude over a plowed field. Apparently the throttle was applied too rapidly, causing the engine to choke up and allowing the airplane to touch the soft ground - - -X!

Case 3. From student's statement: "After attaining an altitude of approximately 500 feet in an N28-3, we executed one simulated forced landing maneuver, regained altitude and began another. As the airplane lost altitude, I noticed wires straight ahead, but I did not warn my instructor, because I thought he saw them too. I do not know whether the engine refused to respond or whether there was a "down

wind", or just exactly why the airplane failed to climb away from the wires. That is the last I remember."

Bureau Comment:- Trees, wires and other obstructions continue to take their toll of aircraft which are carried below the prescribed minimum altitude during simulated emergencies. Engines which have been cooled off in the glide and fail to respond to throttles that are suddenly jammed wide open, are often involved in these accidents. Bu-Aer Manual, "Fundamentals of Primary Flight Maneuvers," page 39, requires that simulated emergencies given over terrain other than designated outlying fields shall not be carried below 150 feet, which means that the maneuver must be completed and airplane back in level flight at this altitude. (Regulations at certain stations specify even a higher minimum altitude.)

An erroneous opinion is apparently held by some instructors to the effect that students must be allowed to carry simulated emergencies to a point where the airplane is actually in the landing attitude. This is not the correct interpretation to be given to this maneuver, except when such emergencies are given near designated small fields where actual landings are made. Simulated emergencies over open terrain are for the purpose of testing the student's reaction in an emergency and to determine: (a) his judgment in selecting a landing place, (b) his judgment in selecting proper wind direction, (c) his technique in keeping the airplane at a safe gliding speed and attitude, and (d) his judgment in planning a good approach. The maneuver does not need to be carried lower than 150 feet for the instructor to learn these essential points about his student. To get the student's reaction to the actual landing, the simulated emergencies must be given over or near designated small fields where the landing may be actually completed, at the discretion of the instructor.

If the instructors cannot be depended

upon to set a good example by complying with flight regulations, there is little hope of expecting students to comply. These "regs" are formulated, in accordance with the general limitations of pilots and airplanes, to protect personnel and equipment.



FATAL DIVE BOMBING ACCIDENT:- A pilot was designated to conduct accelerometer tests in dive bombing runs in an OS2U-1 for research, in cooperation with a senior medical officer, who was to be his passenger during the test. Upon direction and encouragement of the passenger, the pilot knowingly attempted to exceed the stress limits of the airplane in a dive pullout with resulting failure of the starboard landing flap and starboard wing. The airplane fell out of control and crashed with the passenger, who was unable to escape.

Bureau Comment. The experimental nature of the flight, the relative seniority, and the technical and scientific background of the passenger obviously influenced this pilot in his actions; however, the responsibility for this crash cannot be shifted in any way to the passenger since the matter of command of aircraft is clearly defined in the Bureau of Aeronautics Manual, which reads in part:

*Article 13-110.- COMMAND OF AIRCRAFT.

(b) An aircraft taken into the air shall be commanded by a naval aviator, naval aviation pilot, or other person authorized in article 13-103, so desig-

nated by the commanding officer of the unit to which the aircraft is attached.

*(c) Other naval aviators or naval aviation pilots and personnel on board the aircraft, whether or not senior to the person designated as commanding officer, will be either in the status of the aircraft's crew or of passengers, and this status will be definitely understood prior to the flight.

(d) The authority and responsibility of such commanding officer of an aircraft exists from the time he enters it preparatory to flight until he leaves it upon the completion of the flight, during which period the responsibility for the action of such aircraft and its crew and for any occurrence that results from the actions and the aircraft and its crew shall rest entirely upon him.

This accident again accentuates the absolute necessity of remaining within the prescribed operating limits of aircraft, as laid down in bureau Technical Orders. The allowable positive acceleration of this airplane, under the conditions of loading at the time of the accident was 5.5 g. The pilot was repeatedly subjecting the airplane to an acceleration of 7.5 g. Accelerometers should be used when aircraft are being operated near prescribed limits, particularly by inexperienced pilots.

SQUADRONS CALLING

Atlantic to Pacific

" We are now getting News Letter regularly and would like to read more about you in it."



THEY KNOW NOW:- Despite all warnings about the danger of faulty depth perception over glassy water, some pilots continue to make the mistake of trying to use the primary, cut-gun type of approach for all landings. Read the following stories of two pilots who cracked up in the month of January.

Case 1. "After completing an hour of familiarization in a J2F, I made a normal approach for my final landing without power. The sun shining on the slick water temporarily blinded me and I struck the water at 85 knots still in a nose-down attitude. The hull was smashed in and I water-looped to the right."

Case 2. "Upon returning from a tow flight I came in for a normal power-off landing. The water was very glassy and there was practically no wind. I made a normal approach but did not pull up the nose soon enough. As a result, the plane hit the water at about 70 knots with the nose slightly low, causing the main float to dig in. A slight turning effect to starboard caused the port wing float to dig in, throwing the plane on its back."

Grampaw Pettibone says: It's mighty discouraging the way some pilots never get the word. These two fellows must have heard before that it is absolutely dangerous to trust your "landing eye" when it comes to landing on glassy water, but maybe they thought all those warnings didn't apply to them.

I'll bet if you ask them now, though, they will tell you that you should always use a power approach, (same as for night landing on water), when making a landing on glassy water.

CRASH DURING ATTEMPTED INSTRUMENT LANDING APPROACH:- Upon returning from a patrol flight under conditions of increasing darkness and low visibility (haze and ground fog), the pilot of an OS2U realizing that he was low on fuel, elected to make an instrument approach for a landing on his home field. Torch pots were set out to mark the runway. While in the latter stages of his approach, after he had sighted the torch pots just below him, he noticed his altimeter reading to be zero. He evidently became excited at this time because he reduced power and pulled back on the stick as if in anticipation of contacting the runway. The aircraft stalled and fell twenty feet to the ground.

The Trouble Board which investigated this case recommends that pilots be reminded to:

1. Request barometric altimeter setting by radio before making an instrument landing.
2. Observe instruments on landings and take-offs when circumstance permits, particularly the gyro horizon, in order to gain confidence in the instruments.
3. Follow the prescribed procedure of cruising on main tank and of shifting to reserve when landing or flying at or below 500 feet.
4. Follow the prescribed procedure of dropping depth charges at sea when confronted with emergency landings and fuel shortages.



DON'T GET CARELESS WITH SMALL PLANES:- While the pilot of an NE-1 (Piper Cub) was waiting at the edge of the runway for landing aircraft to clear the take-off area, his engine stopped. This airplane was to the left and slightly aft of another Cub. When the engine stopped the pilot left the cockpit and turned the propeller over by hand. The engine caught and the plane commenced to move. The pilot tried to control the airplane by holding on to the right wing, but merely acted as a pivot point around which the airplane moved until its propeller chewed into the wing of the other airplane.

The Trouble Board was of the opinion that this accident was entirely due to carelessness on the part of the pilot (500 hours) in starting the engine of a plane not chocked or attended.

Bureau Comment: Not only carelessness, but also disobedience of orders. Art. 14-101(g), Bureau of Aeronautics Manual states, "Engines shall not be started under any circumstances without an operator in the pilot's seat."

COCKPIT TROUBLE: - Case 1. The pilot of an SB2U landed to disembark a passenger. He then taxied back to the take-off runway. Just as he started his take-off, the landing gear collapsed.

Statement of the Trouble Board: "After questioning the pilot, it is the opinion of the Board that the pilot inadvertently unlocked the landing gear, either while intending to adjust his flaps or lock his tail wheel."

Case 2. While checking out a pilot for night flying, the instructor made a normal landing from the co-pilot's seat and, as the airplane slowed down, turned the controls over to the student. The pilot then ordered flaps up and the student, in his confusion, placed the landing gear switch in the up position.

The Trouble Board states that all pilots in that squadron are now under-

going a blindfold cockpit checkout prior to night flying.

Grampaw Pettibone says:- These are only two of many accidents which occur



as the result of pilots being unfamiliar with cockpit controls. You got to be so intimate with your cockpit that you can instantly locate and operate any control in the dark. And you don't have time to fumble in an emergency!

Blindfold cockpit checkouts are one of the best ways of getting acquainted with the controls and of eliminating cockpit troubles. They should be one of the checks given to pilots before release for flight in unfamiliar model planes.

Yes, I know, planes didn't have so many instruments and gadgets when I started flying. But don't forget, most of these gadgets are put there for your benefit and safety. It shouldn't be a punishment to learn how to use them properly -- it's the best accident insurance I know of.

FOUL RANGE! FOUL RANGE!- Mid-air collisions continue to occur during high-side, fixed-gunnery training runs. The causes of these collisions are almost invariably pilot error. A particularly serious error is that wherein a pilot apparently starts his run and then changes his mind, delaying his actual approach until the pilot in the following plane, think-

ing he has completed his run, starts his run and collides with the preceding plane. It must be mandatory that there can be NO CHANGE OF MIND ONCE YOU ROCK YOUR WINGS AND START IN.

Basic responsibility for safety rests with the pilot making the run to insure that the range is clear before he starts. Once the run is commenced, however, it is that pilot's responsibility to complete the run promptly and, in the words of Grampaw Pettibone, "get the hell out of there," so as not to get hit from behind by the pilot making the next run.

A proper appreciation of the dangers involved and a display of normal intelligence thereafter in insuring a clear range prior to making a run, in executing the run without hesitation once it is begun, and in clearing the range promptly after completing the run, should completely eliminate these destructive accidents.

CROSS-WIND LANDING ACCIDENT -- The pilot of a J2F-5 came in for a landing on the only runway, with a cross-wind of approximately 25 knots on his port beam. After rolling a short distance with its left wing down the airplane commenced a swerve to port. With the use of throttle and rudder the pilot managed to stop the swerve temporarily but as the airplane lost forward speed it again started to swerve into the wind. Right brake was not applied immediately and the airplane went into a violent ground loop to the left, causing considerable damage.

The Trouble Board commented as follows: "It is recommended that all pilots be cautioned again as to the inadvisability of landing an airplane with such a large side surface area in strong crosswinds when other fields are available with runways into the wind. Also, it is recommended that the attention of all pilots be again invited to the necessity of using brake before the groundloop has gone too far.

Bureau Comment: The pilot in this

case was assigned 50% error of judgment and 50% poor technique. Under the existing conditions and with other fields nearby, it is considered that the main error was one of judgment in electing to land where he did.

KNOW YOUR EQUIPMENT:- A pilot in an F4F was forced to make a water landing about 3 miles off shore. He was unable to get out the life raft before the plane sank, but he had on a life jacket and was seen to be swimming for over an hour after the accident occurred. He had received a fractured skull during the landing, however, and lost consciousness and drowned before the crash boat reached him.

When located, the pilot was floating face downward; he had pulled only the left valve on his life jacket which inflated only the sides and collar. Apparently no attempt had been made to pull the right valve as it was still secured with the rubber safety band and the container was found to be in proper working order when later tested. Due to the fact that the right valve would have inflated the front portion of the life jacket, it is possible that this pilot would have been saved from drowning had he pulled the right valve also. Upon losing consciousness he would have floated in an upright position thus keeping his head out of water.

Bureau Comment:- The exact reason why the right valve was not pulled cannot be determined. It is possible the pilot thought that either valve inflated the entire jacket and that the other valve was merely a standby. The fact that the pilot was seen to wave to a circling plane an hour after the accident had occurred indicates that the pilot was physically able to have pulled the valve. Possibly his cranial injuries affected his alertness.

Seemingly, too detailed instruction on the operation and proper use of equipment is impossible. Personnel are again urged to learn the exact operation and limitations of everything they use in flying.

251



51
2



DID YOU KNOW?

Flight Warning Service

You're flying along at 5,000 feet north from Texas to St. Louis around sundown. Suddenly, "weather" sets in. So you cruise around for a while waiting for things to break. No such luck. And the gas is getting lower and lower.

All right, there's an answer to your problem. Contact the St. Louis Communication Station. They'll tell you that the airport is closed, that the ceiling is 200 feet, overcast, with visibility a half-mile, moderate drizzle and moderate fog. Discouraging?? Sure! But they know something you don't. The weather is fine at Springfield, Illinois. So cruise over there and come in. Proceed and land.

The CAA airway traffic control centers are providing just such service for all non-aircarrier aircraft all over the country. It's called the "Change in Flight Plan Warning Service" and its aim is "to warn other than air carrier pilots flying in instrument flight rule weather conditions as to changes in weather occurring after take-off which might make it necessary for the pilot to change his flight plan in the interest of safety."

Flight advisory information forwarded to pilots consists of such suggestions:

1. Advice as to reported icing conditions and suggestion as to most suitable attitude.
2. Advice as to returning to point of departure or proceed to an alternate airport.
3. In the case of a proposed flight in weather conditions below safe minimums, suggest remaining on ground until weather conditions improve along route or at destination.
4. Advice concerning inoperative or malfunctioning radio aids to navigation which might affect the safe conduct of the flight.

These items are merely examples. In actual practice circumstances will dictate many types of solutions to potentially hazardous situations, each case differing with the variables involved, such as the fuel supply of the aircraft, pilot experience, aircraft type and others.

Phraseologies to be used in the transmission of flight advisory information will be as simple as possible, such as:

"ATC SUGGESTS YOU PROCEED TO JOHNSTOWN ACCOUNT CEILING BELOW MINIMUMS AT SMITHVILLE"; or, "ATC ADVISES HEAVY ICING REPORTED BETWEEN 6 AND 10 THOUSAND FEET, ADVISE IF YOU DESIRE CHANGE IN FLIGHT PLAN".

All such flight advisory service communications will be relayed to aircraft in flight through the CAA Airway Communication Stations, Airport Traffic Control Towers and, in some instances, through military facilities. In addition, pilots may obtain this service in person or by interphone direct from the flight controller. Airmen are encouraged to consult with the appropriate center when preparing plans for a flight so that the full benefit of the service may be utilized.

Helicopter's Problems Solved

The Helicopter is now a practical type of aircraft, according to Igor I. Sikorsky, creator of the most recent type.

It is described by some enthusiasts as the post-war aerial "flivver". The craft may play an important role yet in this war.

One Sikorsky machine was flight-delivered recently to Wright Field, Ohio, where it is undergoing exhaustive tests.

"There will be endless refinements", Sikorsky told the Institute of Aeronautical Sciences, "but...the funda-

mentals have been established. All major problems of the single main rotor helicopter have been solved."

"During 1942, the VS-300 proved itself to be totally controllable and completely flexible in its utility..."

"Our helicopter is capable of hovering and flying backward and sideways, as well as forward, with a smoothness of operation noticeable outside and also from the pilot's seat. It can fly at any speed from zero to approximately 80 mph. It can turn or come to a full stop in a remarkably short space. Mounted on inflated rubber pontoons, the craft proves its unequalled amphibion characteristics. It can operate readily from land using these pontoons, instead of wheels. Also, this installation has permitted landing on mud, ice, and on snow. The craft has repeatedly been landed on a small roof and on a pile of engine packing boxes on the company ramp. Recently, a series of landings was made in a deep gully with high banks and piles of dirt on each side, with boats surrounding the spot, and with part water and part mud at the bottom. Under all these conditions there has been not the slightest indication that any undesirable developments might arise."

DON'T TALK



Danger Areas

The greatly expanded aeronautical organization of both Army and Navy has

necessitated establishment of danger areas for bombing and gunnery. In addition, numerous ground installations conduct artillery and anti-aircraft firing up to 36,000 feet. Danger areas are established by Interdepartmental Air Traffic Control Board action and are published in Notices to Airmen and shown on aeronautical charts when reprinted. Existing regulations require that they be avoided unless specific permission to enter is given by the using agency.

The letter quoted below, which was received from the Aberdeen, Md., Proving Center, indicates the necessity of all pilots acquainting themselves with the location of these areas and avoiding them. Clearance officers should have available an up-to-date chart showing the danger areas in the vicinity and along usually traveled routes over which clearance is granted by them. The letter points out the following:

1. Having exhausted all ways and means of prohibiting outside aircraft from flying over the Aberdeen Proving Ground Danger Area the following procedure has been established for operation of this post.

2. Effective at once firings conducted at the various ranges, in areas located within the reservation limits of this post will *no longer* be suspended due to outside aircraft observed in or approaching this area.

3. This post has been forced to establish this procedure due to the large amount of time lost due to violations of this established Danger Zone. This establishment cannot continue to operate efficiently and suspend firings at various intervals at all fronts due to continued violations.

4. It is therefore requested that this procedure be brought to the attention of all aircraft operating in the vicinity of the Aberdeen Proving Ground and that all aircraft enter this area at the risk of being hit by shell fire and bombs.

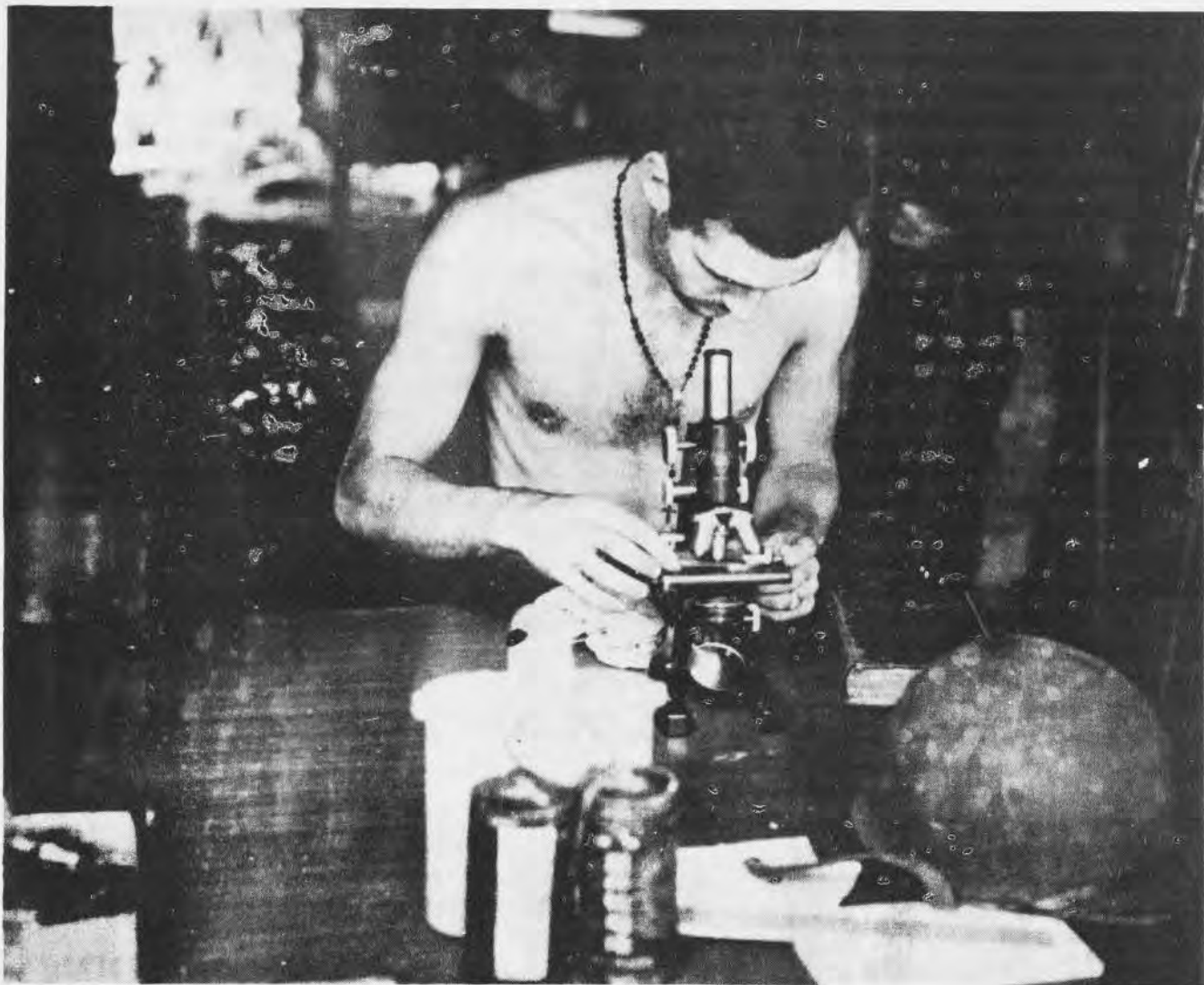

Pharmacist's mate in improvised laboratory on Guadalcanal looks through microscope searching for evidence of malaria.

Malaria - Greatest Killer

This piece is about dive bombers. It is not about Navy dive-bombers. They're on our side.

This piece is about the malarial mosquito, who is definitely not on our side, but he is just as deadly, in his small way, as the Navy's aces.

This mosquito thrives in the tropics; he is hungry, and he never misses. He dives in, singing and stinging, and the victim breaks down in periodic chills and fever.

The thing to do is keep a mosquito bar between you and him, if you just have to go to tropical places. It also

is a good idea to take--under the direction of the surgeon--about ten grains of quinine every day while in mosquito-ridden territory. If there is no quinine, take 2 antebrin tablets twice a week--also under the instructions from surgeon.

To quote one military medical authority:

"Malaria is the greatest killer of the tropics. It can destroy the efficiency of the force; it can deliver it over to the enemy. But do not be downcast by this, for with care its worst effects can be avoided. And that is every soldier's duty."

500 Trans-Atlantic Flights Weekly

"Army and Navy transport groups are now averaging 500 trans-Atlantic flights per week," according to a recent statement by Captain E. V. Rickenbacker. "Day and night all the year round, these transports cross the ocean," said Captain Rickenbacker, "and more planes are being added all the time."

Marking of Contaminated Airdromes

Army landing fields that have been rendered unfit for occupation by enemy's use of persistent chemical agents will be clearly marked both day and night while such condition exists, according to the War Department. Visible warning signals will be used in conjunction with the radio. Gas warning signals will be clear, yet sufficiently inconspicuous to avoid drawing hostile attention.

The following warning signals are prescribed:

(a) *During Daylight:*

(1) Approaching friendly aircraft will be directed not to land. Additional instruction may be given at the discretion of the Commanding Officer.

(2) A rectangular red panel of such size as to be clearly visible will be mounted on the wind indicator or in its immediate vicinity.

(b) *During Darkness:*

(1) Radio: Same as for day.

(2) Visual: (if radio contact cannot be made) A succession of transmissions of the letter G via white light from control tower or by standard air-ground signal communication light.

AAF Memo of Interest

Following is an AAF memorandum pertaining to the discarding of vital equipment during ferry flights to war zones. Its contents are believed to be of general interest.

It has often been reported that much vital equipment is removed and discarded prior to departure of aircraft leaving the United States for foreign theaters. Extremely necessary items such as special engine and accessory tools, carburetor filters and dust excluders, small maintenance parts, handbooks, etc., are both *negligently* and *intentionally* removed in such manner as to prevent them from reaching zones of operation. It has even been reported that crews throw these items off the aircraft between the hangar line and the take-off point. Such practices will not be tolerated. It is imperative that these items reach their destinations.

It will be forcibly impressed on all concerned that such items - or the lack of them - *make or destroy* the effectiveness of our air force, that they are extremely hard to procure, and that manufacturing facilities and material resources are obligated to their greatest capacities to fabricate them. Failure to deliver essential items is flagrant violation of the responsibility and trust imposed upon the military services and, what is worse, imperils the successful prosecution of the war.

It is directed that every effort be made to study all loading requirements for safe delivery of airplane and cargo, especially at concentration points. When the pilot feels that the load should be altered he should say so and the situation remedied *before take-off* (not after flight has commenced), so that material removed may be adequately taken care of.

DON'T TALK





Practice Silence

Button Your Lip--if you're a fighter pilot in action. Don't talk when you should be listening. Your wing man doesn't want to hear what you think of Hitler or Togo. He has other problems. And he's probably thought of the same expletives himself. Radio "chatter" can and has cost lives in battle. Use it sparingly.

What's more, radio SILENCE can be a vital asset. Your base or squadron commander may have something to say. Perhaps there's a dozen ME 109s or Zeros coming in at 30,000 feet from the southwest. Perhaps there's a concentration of anti-aircraft batteries on your target course. Nice things to know, don't you think? All right, then. Cut the battle chatter and keep the circuits clear.

There are times, of course, when you may have something important to say. If it is battle information, if it is a warning to a fellow flier, by all means say it--quickly and clearly--then snap the mike. And listen!!

Military Funds

The Bureau of the Budget reports as follows on Army Air Forces and Naval Aviation appropriations, and unexpended and unobligated balances for the period from July 1, 1940, to Dec. 31, 1943.

Army Air Forces "The total provided for the AAF amounted to \$36,661,000,000. Expenditures to Dec. 31, 1942, had amounted to \$7,292,000,000 and unliquidated obligations totaled \$22,168,000,000, making a total obligation to Dec. 31, 1942 of \$29,460,000,000. Commitments had been made aggregating \$2,166,000,000, leaving an uncommitted balance of \$5,035,000,000. It is contemplated, however, that contractual negotiations now in progress, including purchase actions initiated for the procurement of aircraft, spare parts, and other aeronautical materials and supplies, together with personal services and operations and maintenance, and purchase of certain special equipment by the Corps of Engineers, will result in the complete obligations of all funds available to the AAF by June 30, 1942."

Naval Aviation "There has been provided under the appropriation title 'Aviation, Navy', a total of a little over \$12,100,000,000 in appropriations and contract authorizations. However, the present unfinanced contract authorizations amount to only \$240,000,000. Obligations and commitments to Dec. 31, 1942, under this program amounted to \$9,300,000,000, leaving an uncommitted and unobligated balance of \$2,800,000,000. The Navy Dept. estimates that it will obligate the \$2,800,000,000 by July 1, 1943.

"Under the appropriation, 'Aviation, Navy', it is estimated that the total of \$12,140,000,000, which is available, will be obligated during the 3 fiscal years ending June 30, 1943. Expenditures against these obligations will amount to a little over \$5,000,000,000, leaving a little less than \$7,000,000,000 of unexpended appropriations at the end of the fiscal year 1943. In air-

Naval Air Station, Lakehurst



craft procurement, it has been necessary to make obligations substantially in advance of the delivery of finished planes, and this in general accounts for the large amount of unliquidated obligations to be carried beyond June 30, 1943. Initially, this program was financed through the medium of cash appropriations and substantial contract authorizations. It was subsequently considered desirable to appropriate cash to take up most of the contract authorization, and this action has also contributed to the large cash carry-over.

Catafighters - Britain's Answer

British ingenuity and training have met the deficiency of escort carriers by catapulting Hurricane fighters from merchant vessels! Special training has produced the Catafighters --- fighter-pilots who go aloft in these pursuit planes to protect their convoys against attack.

A year ago British convoys to Murmansk were under almost constant attack by German Focke-Wulf Kuriers from Norwegian airports, but the Germans now have ceased to boast of any large-scale bombings of convoys. The Catafighters have been responsible for this. Their planes are catapulted from the decks of lumbering freighters the moment enemy planes are sighted. On the Murmansk run Catapilots must stand by their aircraft in summer from 24 hours of perpetual daylight, their engines warmed and ready at split-

second's notice to take to the skies for combat.

Catafighters are experienced airmen with fighter and catapult plane training. The planes used are specially-strengthened Hurricanes which rocket down a 70-foot track, attaining a speed of about 75 miles an hour at the moment of launching.

The catafighter has orders to "stay up there and fight until he makes the kill or runs out of gas." The planes are potent in beating off enemy attacks, but they never can be recovered. Unfortunately, the pilots, too, must sometimes be sacrificed. Today, however, the technique of rescue has been greatly improved. The pilot signals the nearest escort vessel when his fuel is nearly exhausted, rolls his plane over and bails out, half a mile in advance of the ship's course. This distance insures that the plane will crash into the ocean instead of hitting the vessel. On striking the water, the pilot possibly inflates his "Mae West" and rubber dinghy. In a few minutes he is back aboard, with a hot drink and a hot bath awaiting him.

The catapult system costs a plane every flight, but it saves many ships with valuable cargoes of foodstuffs and essential war supplies. The more successful the catapult planes are, the more uneventful becomes the life of the Catapilots -- proof that ingenuity and courageous men are vital weapons in warfare.



FLEET AIRCRAFT



WINDS ALOFT

"What are the winds aloft?" asks the pilot of a TBF before climbing into his plane on the flight deck.

It is the aerologist's job to furnish the detailed information on surface and upper air weather conditions required for aircraft operations.

The cover of this issue of NEWS LETTER shows aerographer's mates making observations of winds aloft with the use of theodolite and pilot balloons ("PIBALS").

This operation, familiar to many, is made at various times during the day.

Once the balloon has been released, its path is followed by the theodolite. Azimuth and elevation angles are simultaneously recorded at 60-second intervals. Wind direction and speed are computed with the use of a weather board that compensates for the movement of the ship.

Using anamometers (wind gages) and wind socks, the aerographer supplements his findings with numerous checks on winds sweeping along the flight deck of the carrier.



AIRCRAFT CARRIER BOX SCORE

In the far reaches of the Pacific, the United States and Japan, struggling for sea-air mastery, concentrate attacks upon each other's carriers. The chart below, drawn for Current Aviation, shows the United States forging ahead rapidly in this contest. Since the chart was drawn, the Yorktown has been launched. Recent action has accounted for the probable sinking of two more Jap carriers.

SUNK	U.S.A.	LEXINGTON YORKTOWN WASP HORNET	RYUKAKU	AKAGI	KAGA	SORYU	HIRYU	(Name Unknown)	RYUZYO	SHOKAKU	OUR FIRST BUT OBSOLETE CARRIER "LANGLEY" WAS ALSO SUNK AT THE START OF THE WAR WHILE ACTING AS A CARGO SHIP.
	JAPAN										? JAP CARRIERS DAMAGED AND POSSIBLY SUNK.
AFLOAT	U.S.A.	SARATOGA ENTERPRISE RANGER									* CONVERTED MERCHANT SHIPS USED AS ESCORT AIRCRAFT CARRIERS.
	JAPAN										* CONVERTED MERCHANT SHIPS SEVERAL OF WHICH MAY HAVE BEEN SUNK.
LAUNCHED	U.S.A.	BUNKER HILL BELLEAU WOOD PRINCETON LEXINGTON INDEPENDENCE ESSEX COMPENS-1943									LAUNCHED IN 1942. COMPLETION TAKES SIX MONTHS TO A YEAR.
	JAPAN										NO DOUBT SOME JAP CARRIERS WERE LAUNCHED IN 1942. OUR PLANS AND PRODUCTION ARE MUCH GREATER.
U N R E P O R T E D											F. B.

IDENTIFYING MINESWEEPERS AND GEAR

Not long ago a U.S. bombing plane in a combat area mistook the wake of minesweeping gear streamed from a U.S. sweeper to be that of an enemy submarine periscope and bombed it. To avoid any repetition of this incident the following photographs are published to aid in the recognition of this equipment.

Photograph No. 1 shows a YMS class of vessel which is a 136 foot minesweeper, with the moored gear streamed from the starboard side.

The small wake off the starboard quarter is made by a float, which is towed by the vessel. This float is what has been mistaken for a submarine periscope. This gear, which may be streamed from either or both sides, is usually adjusted so that the float is about 260 yards astern and 150 yards abeam of the vessel. In other words, the float is about 30° on the quarter of a vessel and at a distance of 300 yards.

Photograph No. 2 shows the same type of vessel with its magnetic gear streamed. The magnetic tail is 575 yards long and follows directly in the track of the sweeper.

Since the ultimate design of a mine and its firing mechanics are influenced tremendously by the sweeping technique and equipment of the enemy, it is hoped that these photographs will further serve as a reference for identifying enemy minesweepers and minesweeping operations. Any pictures taken of enemy operations will be extremely valuable for determining what means and methods are employed.



Minesweeper with moored gear streamed from starboard side.

Minesweeper with magnetic tail following directly in sweeper's track.

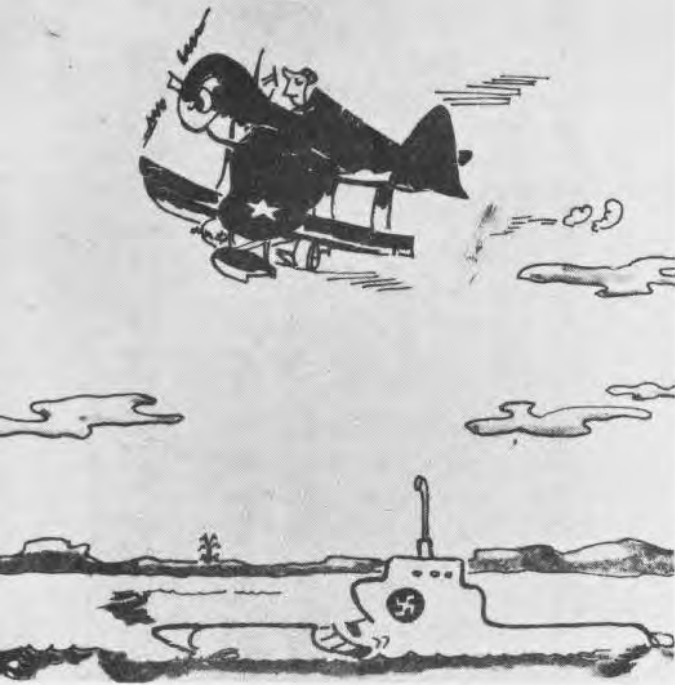

1

1. Dilbert sights submarine (?).

DILBERT--

"SIGHTED SUB, SANK SELF."

(With apologies to the original Dilbert)

U.S. Atlantic Fleet, Fleet Air Wing 11, Scouting Squadron 4-D10 sent in this contribution of Artist Graber. It appears that Dilbert actually was allowed to go out on sub patrol the other day. A sub was sighted. Dilbert threw himself into the attack with an enthusiastic "Talleyhoedown!" and succeeded in out-maneuvering an OS to attack. However, being a trifle slow on the pull-out, Dilbert really pressed home the attack and was able to report proudly to his base, "Sighted Sub, Sank Self."

2

2. Dilbert succeeds in out maneuvering an OS to attack.

3. Dilbert reports to base, "Sighted sub, sank self".

3

Navigational Publications

The attention of commanding officers of Naval Aviation activities is invited to the fact that Hydrographic Office charts and publications must be ordered from that Office direct on Form N.H.O. 754. Letters addressed to the Bureau of Aeronautics requesting such material create unnecessary delay and paperwork.

The Hydrographic Office fills orders from Naval activities received on Form N.H.O. 754 without charge to the requesting activities, excepting schools. Material for the use of the Aviation Cadet Program is handled as outlined below. Requests specifying shipment by airmail can be kept to a minimum if needs are properly anticipated.

Delay in the receipt of material by the ordering activity is caused by the following:

(a) Nautical or Air Almanac incorrectly ordered from the Hydrographic Office (It is distributed by the Naval Observatory.)

(b) Dutton's Navigation and Nautical Astronomy, Knight's Seamanship, or other text books incorrectly ordered from the Hydrographic Office (They are distributed by the Library Division, Bureau of Naval Personnel.)

(c) Other charts, publications and material ordered which are not issued by the Hydrographic Office. (See note on Form N.H.O. 754.)

(d) Charts listed by consecutive numbers instead of by chart numbers.

(e) Confidential charts ordered on same form with non-confidential charts.

(f) Confidential charts ordered when the vessel is not on the allowance list for them and without authority from CinCLant, CinCPac or CominCh.

(g) Requests for Hydrographic Office material which are not sent direct to the Hydrographic Office.

(h) Requests for charts and publications which are not submitted on Form N.H.O. 754.

Flight Preparatory Schools, Pre-Flight Schools, Primary Flight Training, Intermediate Training Center, and other schools of the aviation cadet training program are furnished with Hydrographic Office material through a schedule set up by the Training Division of the Bureau of Aeronautics. Requests from individual schools to the Hydrographic Office or the Bureau of Aeronautics are not required and there is no charge to the school. In case a shortage develops it should be reported to the Bureau with recommendation for a certain increase in schedule. Scheduled shipments are sent out by the Hydrographic Office on the 15th of the first month of each quarter.

Flight Instructor's School

BLOOMSBURG, PA. - The Navy CAA-WTS Flight Instructor's School has been in operation since November 15, 1942, under the direction of Lieutenant C.L. Clabaugh, a naval aviator. Lieutenant John Boyd, formerly of the Navy Pre-Flight School at Chapel Hill, is in charge of physical training.

The airport, operated by the Ailor Sales Corporation, is situated on the north bank of the Susquehanna River. Not more than three quarters of a mile from the field, on the summit of a ridge, stands the century-old Bloomsburg State Teachers college, where student officers live and attend ground school courses. At present there are 165 student officers enrolled and the quota of 210 will be reached in the near future, it is believed.

Many fliers who crashed into the water have lost their lives because they were unable to use the rubber boat provided in each plane. At Bloomsburg, hours are spent in teaching students the simple art of using a rubber boat.



Joins Navy Trainers

NAS-ATLANTA -- Shades of "Mr. Milligan"! The offspring of this famous old gentleman of the skies has joined the Navy. Designed and built by "Go Greese" Benny Howard, the new recruit, the NH-1, bears a striking outward resemblance to its renowned forbear. To this sturdy aircraft, proven by years of commercial operation, has been added an array of instruments and radio equipment probably never before installed in an airplane of this type and size.

The NH-1 is the most recent addition to the Naval training program. It is receiving its indoctrination at the Instrument Flight Instructors' School at Atlanta, Georgia, and is already making a name for itself. The NH-1 seats four passengers with all the comforts provided by a cabin-type plane. It has built-in parachutes, cabin heat, and serviceable upholstery.

Fully functioning triple controls have been installed, allowing the plane to be controlled by the instructor or the student observer in the front, or by the student in the rear receiving instructions under the hood. Three radio receivers, one receiving on a

frequency of 200-400 kilocycles and the remaining two ranging from 200 to 6600 kilocycles have also been installed. A 50-watt transmitter is designed to broadcast on four frequencies depending upon the crystal used. For Radio Direction Finding Work, the student in the rear can control the position of the loop antenna, the indications being registered on a duplicate pointer and azimuth scale in the front, enabling the instructor and student observer to watch the procedure. The instructor and two students are connected by interphone. A completely equipped panel set up especially for attitude instrument flying completes the layout.

It is believed by IFIS that manifold advantages may be derived by having one student observe another while flying. For this the Howard is perfectly adapted. The instructor takes two students out at once, allowing them to fly and observe alternately. The instructor also takes his turn under the hood, acting as student, giving the students practice as instructors. By using this system, a training plane remains in the air for three hours, eliminating time consumed in returning to Base to change students each hour, as formerly done.

Air Gunners Schools Report Success

It has been learned with much satisfaction that the Naval Air Station, Kaneohe Air Gunners Training Unit has several Jap planes credited to its graduates. This news suggests starting an honor roll at all schools and units on which could be inscribed the names of those Alumni who distinguish themselves in action.

NAS, Pensacola Gunnery Schools have done an outstanding job in training both officer instructors, and men for combat duty. The moving target range recently installed at Gulf Beach has certain features that give it unusually training value. Battle ranges and normal deflection speeds have been made available to the students. The Bureau considers this range a fine example of good planning.

Cadet Training Program

ST. MARY'S PRE-FLIGHT - By the time naval aviation cadets reach pre-flight school they will be pretty thoroughly schooled in academic subjects and military procedure, when the Navy's present plan to furnish instructors to War Training Service courses materializes.

The WTS course, which is a development from the former CPT program, bridges the gap between the student's instruction at Flight Preparatory and his entry into pre-flight school.

By the time the cadet reaches WTS, he has already been grounded in the fundamentals of academics and military lore at flight preparatory school.

The Navy wants to make sure that during the two months of WTS study, in which the cadet flies for the first time, his valuable store of academic knowledge has not been wiped out.

Four flight preparatory schools - Texas, Washington, Southern California and San Luis Obispo - are expected to feed 800 students a month to WTS schools. These schools will in turn furnish cadets for the two Pacific

coast pre-flight schools - St. Mary's and Del Monte.

It Can Be Done

In a race with routine, a billeting record was established at the Naval Flight Preparatory School, University of Virginia, recently. Ninety-five Aviation Cadets arrived at the station with an officer from the Washington Selection Board. In 45 minutes flat: their luggage was piled quickly on a truck, they hopped into buses, and began their streamlined routing; arriving at the school, each man was issued a key to his quarters, his textbooks, Cadet Regulations, schedules of week's activities; muster was called; a cadet who had sprained his ankle was taken to a hospital; and the entire group was quartered in their rooms -- at rest.

The following day another group of 100 cadets, not to be outdone, accomplished the same feat in the same time -- and marched three-fourths of a mile from the station besides!

Naval Pilot Honored

Tribute to the memory of a naval aviation hero was paid recently when a full-size replica of a destroyer bridge was commissioned the USS Richard S. Bull Jr. at ceremonies at St. Mary's Pre-Flight School, Moraga, Cal. The bridge was erected by station employes to honor Lieut. Richard S. Bull Jr., USN, who was lost in an air battle over the Coral Sea. He was awarded the Navy Cross posthumously.

At the commissioning ceremony, Mrs. Lee Bull, widow of the hero, was sponsor of the bridge and presented the station with an inscribed plaque which will be mounted on the bridge bulkhead.

Equipped with mast, yard-arm, signal halyards, ship's bell, annunciator's compass, binnacle and wheel, the USS Bull will be used for cadet instruction in seamanship. It is so located that it forms the backdrop for all graduation exercises and special ceremonies conducted at the school.



Dilbert was just an accident looking for a place to happen but if you'll keep an eye on him you'll learn quite a bit about flying.



Dilbert never realized the Automatic Eliminator was always ready to give him a down for carelessness.

ALARMS AND EXCURSIONS OF DILBERT

Dilbert, who still thinks that the Automatic Eliminator is a kind of laxative, proceeds on his disastrous way. Enroute he's giving plenty of aid and comfort to the enemy. In fact the Japs feel that Dilbert is their White Hope for an early victory.

However, just because there are a few Dilberts who make silage out of government property, the name "Dilbert" should not be applied to all Navy Cadets. The average Cadet will obviously resent being classed as an "idiot boy" until he has pulled a "dilly".

It has been noted that some Naval Air Station put up Dilbert posters in groups instead of showing them one at a time. While more effort is involved in hanging a new poster each day in the exhibition box, results have been found to warrant the extra trouble. The Cadet gets in the habit of looking for the new "boner" and has a better chance of remembering it because he is not distracted by several possible errors. Individual showing of the posters also reduces the likelihood of their be-

coming monotonous or commonplace.

For any Stations which have not received sets of Dilbert some examples of his idiocy are shown in this spread. In general the 264 posters may be grouped under the following heads:

Primary flying, shooting circles, pylons, acrobatics, instrument flying, formation flying, ground school, medical, navigation, parachutes gunnery, radio, recognition, engines, gas systems, propellers and switches, flat-hatting PBYS, Os2Us, VF, Aerology, sleeve runs, military bearing, in fact all the human errors that make Dilbert's flying such an earth-shaking affair.

If instructors feel that they are turning prematurely grey or are getting stomach ulcers from hearing about the flier who was SURE his main tank was full they can write to: Training Literature Section, Buaer, Washington, D.C. with a short note on what they teach and how many copies of posters are needed. Posters will be supplied as promptly as possible.

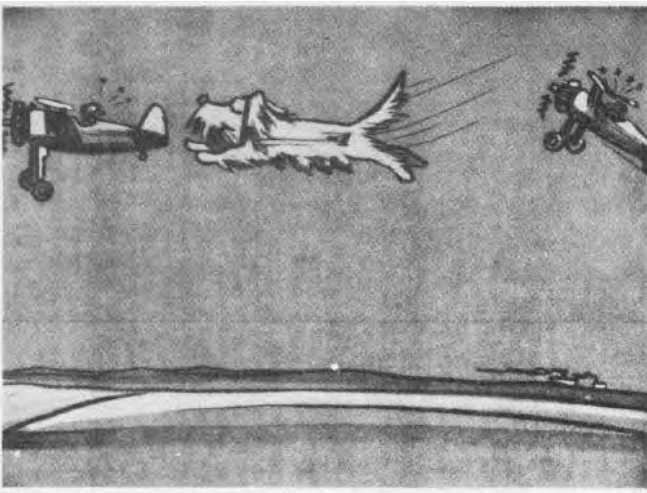

Dilbert didn't improve the traffic circle



Dilbert hadn't bothered much about manifold pressure

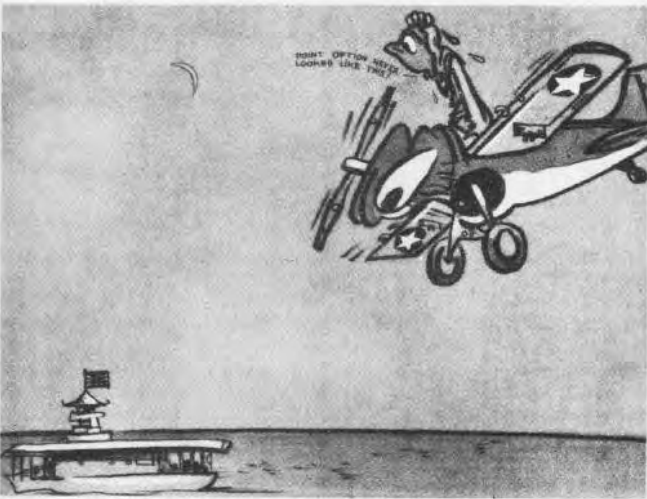

Dilbert's navigation left much to be desired

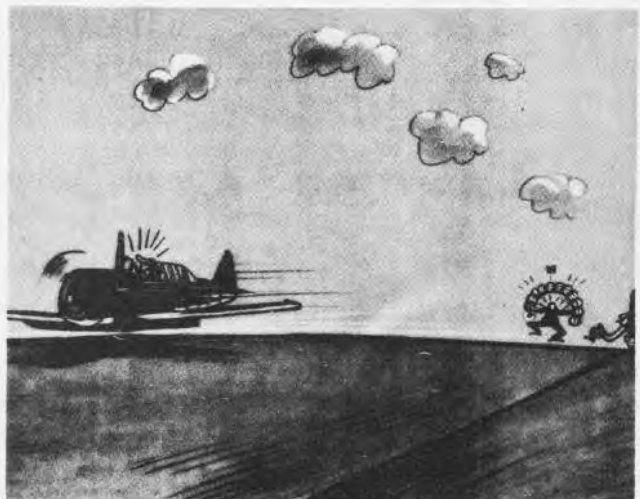

A "wave off" didn't bother Dilbert

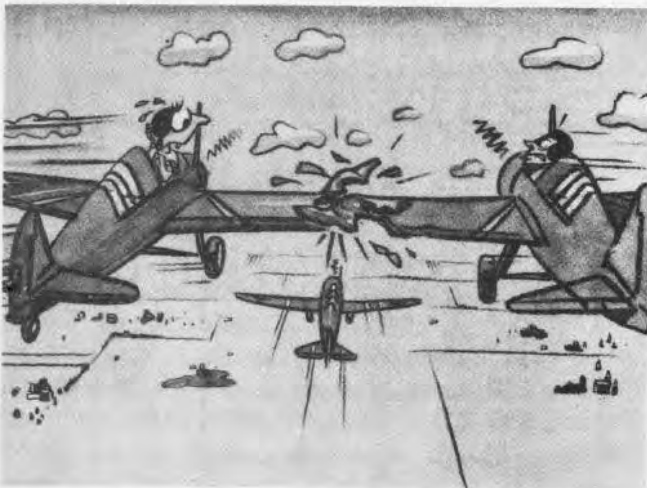

Dilbert moves even though he doesn't understand the signal



Well, anyway Dilbert understood the theory of navigation



To Train Instructors

NAS, NEW ORLEANS - The change-over here from a primary training center to an instructor school is being accomplished rapidly. It is believed the instructor school can be in full swing by early April or possibly sooner, at which time the primary instructor schools at Pensacola and Corpus Christi will be closed. This station will train instructors for the Primary Training Command at the rate of about 300 a month.

Gunnery Training with Shotguns

The Gunnery Training Section strongly endorses the use of the ring sight by all students who have passed the initial familiarization stage, which in no case should exceed 100 rounds of firing. This statement was made to clear up any misunderstanding that may have existed regarding the Training Division's views on the subject.

Formal skeet scores should not be considered a criterion on which to weigh the merits of the ring sight. The student does not shoot down enemy fighters with shotguns, and of prime interest is his score with a .50 calibre machine gun. Modification of standard skeet courses has been suggested by several activities to meet the requirements imposed by use of the ring sight.

SIGHTS: The 35 mil ring or reticule is the standard unit for free guns. Training with any other size ring should be discontinued. By standardizing on this unit, confusion in the matters of range and apparent speed estimation will be avoided. The addition of a 70 mil ring outside the basic 35 mil ring should serve as an added reference mark and should help rather than confuse the gunner who is properly trained. While on the question of sights, all students should be taught how to replace quickly a burned out bulb in the Mark IX.

ORDNANCE TRAINING: The type of operations that our Naval Air Forces have been called on to carry out in this war require a wider knowledge on the part of aircrews than ever before. These are many occasions when the gunner, as radioman or mech, has to service the weapons, boresight, load, and fuse bombs, as well as help check engines and repair damage to his plane.

Naval College for Enlisted Personnel



Enlisted personnel of the U.S. Navy and U.S. Naval Reserve who meet certain requirements may apply for assignment to the Naval College for Enlisted Personnel. Basic requirements are:

- (a) Moral and physical qualifications for commission rank (visual acuity of 18/20 in each eye),
- (b) Minimum education of graduation from high school with creditable scholarship rating and maximum education of not more than three years of college completed. (Men having two or more years of college are eligible for the Reserve Midshipman program.)
- (c) Be between 17th and 23rd birthday on day application submitted.
- (d) Be unmarried and agree to remain unmarried until commissioned, unless sooner released by the Navy Department,
- (e) Sign statement of willingness to accept change in rating to Apprentice Seaman prior to enrollment at college to which assigned.



Training Films



Film Slides Converted Into Training Pamphlets

A series of nine pamphlets on Familiarization With Air Craft is being prepared by the Training Division of Bureau of Aeronautics from slide films furnished by the Ground Schools Section. These pamphlets will be distributed about April 1 for the training of Naval Aviation Cadets, as an additional method of presenting material of great value. The following subjects are covered:

- The Pilot Meets the N3N.
- The Pilot Meets the N2S.
- The Pilot Meets the NP1.
- The Pilot Meets the NE.
- The Pilot Meets the SNJ3.
- Flight Instruments.
- Flight Control Systems.
- Parachutes.
- Airway Aids.

Film Officer's Duties Increasing

As the Training Film programs progress it becomes more and more evident that some immediate action should be taken by every Command, every Base and every Station to review their stock of training films and bring these operations up-to-date.

More than \$9,000,000 already has gone into making training films for the Navy, and there is no longer any question as to their value. Films save vital time in teaching, training and indoctrination. They can waste vital training time if carelessly or improperly used.

Much progress has been made in film utilization, but there are still many instances where motion pictures and slide films are not being used to

anything like full advantage. The Training Officers and Instructors want films. Some positive action is required to insure that every Base and Station is receiving films and showing them on regular schedules--and that the films which are being used are the best available for their purpose.

There are more than 3,000 motion pictures and slide films available for service use. Another 1,000 are in production. Obviously, only a small portion may be shown by any one establishment. Therefore it is necessary for every Base and Station to assign an officer to co-ordinate and service their specific film needs.

If there is no Training Film Officer aboard, some officer should be assigned permanently to this duty.

The Training Film Officer is in charge of audio-visual aids, and has cognizance of all training films and equipment. He administers the central film library, and consults with and assists all departments in ordering, scheduling and showing training films for teaching, training and indoctrination.

Since training films are being used by practically every activity aboard, the Training Films Officer must maintain contact with all departments, usually through a Film Liaison Officer, designated by each department head.

Training Films are serviced in two broad classifications.

(1) Films for use in teaching. These should supplement Ground School, Academic, and Technical instruction courses for aviation cadets, instructor pilots taking refresher courses and A&R Shop personnel. The department supervising these courses selects applicable films and incorporates them in the syllabus.

(2) Training and indoctrination films. These include Indoctrination, Hygiene, Military Training, Morale, and News films. They are usually selected and scheduled for regular showings by the Military Regimental or Executive Department, or Superintendent of Training. Once more, the department units supervising specific activity select

and schedule showing for aviation cadet, boot-camp, and base personnel training and indoctrination. Some bases schedule these for evening programs.

Films scheduled on the programs above are not to be considered substitute rainy day procedure, or only used when weather does not permit flying. They are selected and designated for showings as a part of the curriculum.

Other films applying to the various subjects should be selected and designated for OPTIONAL showings.

It is also necessary for the Training Commands to co-ordinate use of films in their units.

REMEMBER -- THERE IS A FILM SHORTAGE!

The unprecedented use of film in all branches of the service has increased the shortage of film stock. An abrupt curtailment of motion picture activities by the Army and Navy and commercial producers will be necessary unless wasteful practices are stopped.

All obsolete motion pictures which may have accumulated in its various aeronautical units be turned in to the BuAer photographic Division for reuse.

The Photographic Division is eliminating duplications and distributing only those films bearing directly on specific training activities.

Requests for training motion pictures by all units of the four fundamental training commands must be forwarded to the Bureau of Aeronautics via the Chief of their training command.

When new training films are available, one copy will be sent to each of the training commands for review as to its suitability for training units of that command.

New films will be sent to fleet units as completed. Additional requests should be forwarded to Training Film Section, Bureau of Aeronautics.

UTILIZE FILMS -- DON'T WASTE THEM!

Call 'em Information Officers!

To avoid confusion with the functions of the Office of Naval Intelligence, the Naval Air Combat Intelligence School, NAS Quonset Point, is now referred to as the Naval Air Combat Information School. Consistently, graduates of the school are referred to as Air Combat Information Officers. (Ref: BuAer ltr Aer-P1-71-Ek over On22, dated 2/2/43).

Air Combat Information Training

Within a year, the Bureau has graduated and sent to battle areas more than five hundred Air Combat Information officers. The most recent graduation from the ACI school at Quonset Point, Rhode Island, was on February 20. Graduates have left for their billets, from Alaska to Australia, Greenland to Africa.

The ACI school is an entirely separate unit from the Bureau Indoctrination School on the same station. The Indoctrination School, however, under the guidance of Lieut. Commander Zitzewitz, supplies most of the candidates for ACI.

The Bureau organized and opened the ACI school in January 1942, to train officers in collecting, evaluating, and disseminating air combat information. The first class was composed of sixty students, fifty from the Indoctrination School.

Courses now include: procedure, recognition of ships and planes, maps, charts and aerial photography, air tactics, navigation, aerology, ordnance and communications. The course is covered in eight weeks.

The faculty for the school has been drawn from the United States Naval Academy, Harvard, Yale, Princeton, and Cornell. Skilled instructors have been brought in from the Navy, the Marine Corps, and the Royal Air Force.

Most of the graduates have gone with squadrons, aboard carriers or on shore bases. In general, the billets are divided as follows: Staffs, Intel-

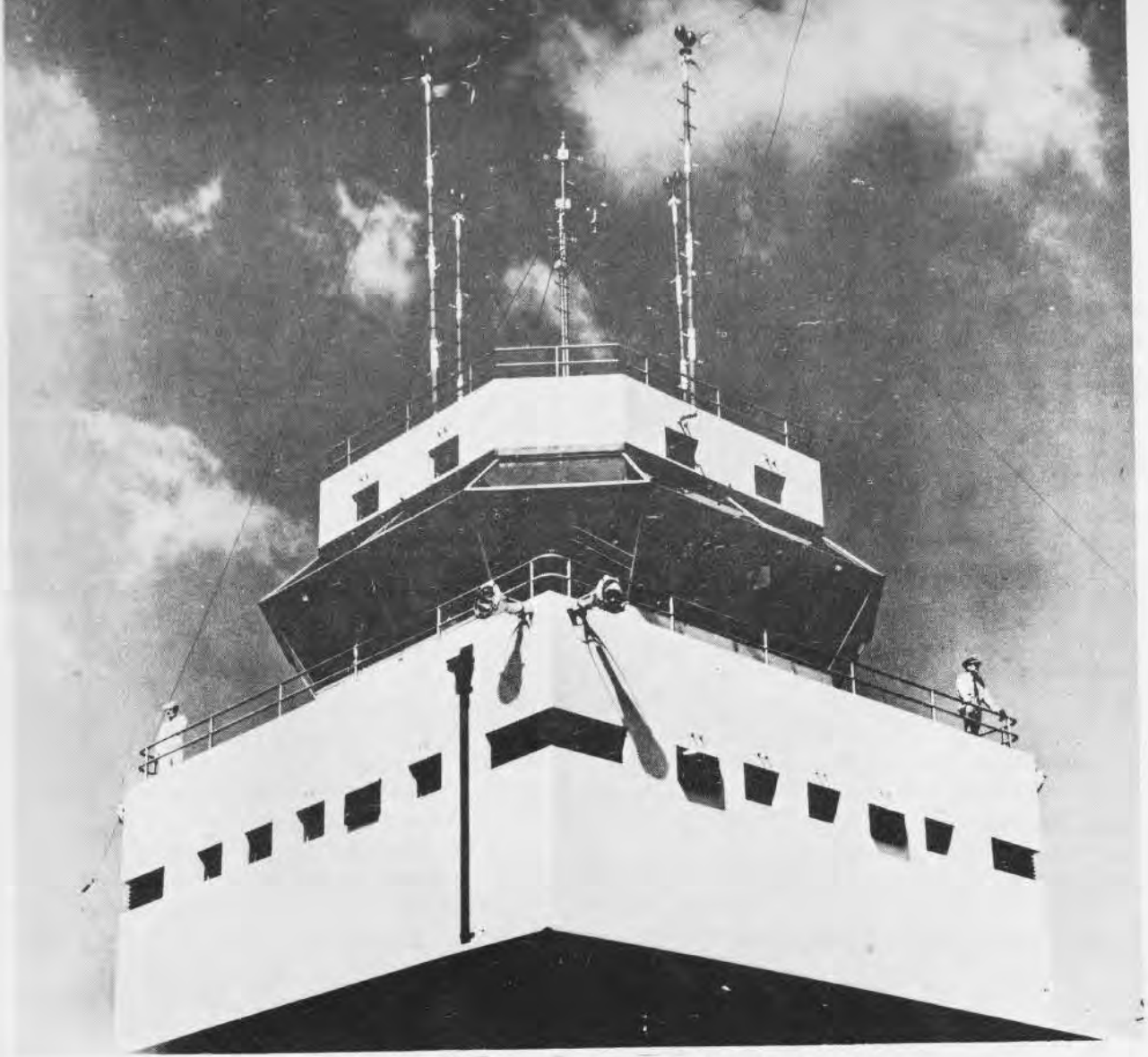

Control Tower, USNAS, Quonset Point, R. I.

ligence Centers, Sea Frontiers, Naval Air Stations, Carriers, Squadrons, and Amphibious Forces.

The ACI officers are volunteers, between the ages of twenty-eight to forty-five, and are carefully selected as to professional background, training and ability.

A description of their work is contained in an ACI school statement: "It is easy enough to state the general function of the ACI officer, to collect, organize, analyze, evaluate and disseminate all information essential to the flying forces. It is not so easy to describe the actual processes by which this end is to be gained. The ACI officer must be capable of living

with the squadron, helping the pilots and crews in every way possible, briefing them when called on to do so, and always interrogating them after flights with understanding, tact, and skill. He must be equally prepared to become a recording and disseminating bureau far from the noise of the planes and guns, organizing the basic information, getting it in one direction to Washington, in the other to the farthest advanced base. Between these extremes, there are endless stages and combinations, and he must always be ready to be, for the moment, a Communications Officer, a Rear Seat Man, or a Mess Treasurer. But however ready to help out, he must be free when the crisis

calls to be an Intelligence Officer one hundred percent, the man who tells us more accurate facts about the enemy than the enemy knows."

The Indoctrination School, from which most of ACI officers are drawn, is a tough, thorough school providing quick transformation from civilians to officers. The schedule begins at 0600 and ends at 2215. In addition to physical training, the students are given a vigorous course in the fundamentals of naval service, plus a mass of technical instruction on naval aviation.

Waive Comment?

NAS, ANACOSTIA - When is a WAVE a nuisance? A Chief Petty Officer is supposed to be a good authority for nearly anything you want to know, so this quotation from a letter written by C.P.O.'s at Anacostia to the newly arrived WAVES aboard the station ought to be revealing:

Dear WAVES:

We like you, one and all. We know why you are here and we are willing to cooperate in helping you to accomplish your mission (Witness: Didn't one of us take a couple of you out to the National Airport, despite the gasoline shortage, to show you how to manage a "time shack," and isn't another of the boys working overtime trying to make life in the Personnel Office bearable for a whole flock of you?

The instances quoted above were only quoted to prove that we like you and are doing all we can to make things easier for you and we will continue to do all we can for you, but ladies, PLEASE, DEAR LADIES, is it necessary that you, each and every one of you, patter to and fro at least one dozen times each morning with your hard leather heels clicking at each step right over our head when we are trying, oh so hard, to catch that last 2-1/2 minutes of "shut-eye" before tearing ourselves loose from the blankets?

Yours for undisturbed sleep,

The C.P.O.'s

Air Navigation Training

The rapid expansion in the number of pilots required to be made available to the Fleet has revived the old discussion of having non-pilot navigators aboard large naval aircraft. It has been felt that this, as a routine thing, is undesirable, and it is not proposed to adopt such a system. However, extra pilots can be made available if a non-pilot navigator is used temporarily. As a result, a plan has now been adopted whereby a certain number of aviation cadets graduating from the Pre-Flight Schools may volunteer for navigation training. These cadets are then sent to the Naval Air Navigation School in Florida for specialized training in aerial navigation. Upon the completion of this course they will be commissioned ensigns and will be assigned to patrol planes as navigators.

No officers other than V-5's are eligible for this training. At the conclusion of one year's duty as navigator these officers will be sent to Primary Aviation Training to begin their flight training.

Just as Sweet



IOWA PRE-FLIGHT - Cadets have learned that a red-head in the Navy isn't a "strawberry blonde" but a "portside blonde," so called because red lights are always shown on the port or left side of a ship.

SHORE STATIONS

Lessons Learned From PBY Crash

NAS, ASTORIA, ORE.- A recent tragic crash of a PBY-5 brought to light a series of events, which through their happening, may save the lives of other pilots who find themselves in the same predicament in the future. The PBY-5 was flying on the airways in Oregon when a bad icing condition was encountered. The pilot, apparently desiring to get on water in the event of a forced landing, turned off the airways and subsequently made a crash landing in a rough sea off the Oregon coast. In a short time the plane sank, the pilots and crew abandoning it by portable lifeboat and life raft. When the heavy beach swells at the base of a rugged cliff line were encountered, the boat and raft were overturned, and only one pilot was eventually washed ashore alive.

Once the PBY-5 left the airways, no notification was given to intermediate control stations, with the result that Naval Air Station Tongue Point heard nothing of the impending disaster until the situation had reached dangerous proportions. Efforts to establish radio contact with the plane were then unsuccessful. The first word received that the plane was lost and in trouble, was from the Coast Guard which reported that it was on the water.

Several lessons can be taken from the crash.

First, all surrounding stations should be notified immediately if a plane is in apparent danger, so they will have an opportunity to prepare their emergency facilities.

Second, a pilot should never begin to "hunt" frantically back and forth on his radio in an attempt to pick up a station. He should remain on his assigned frequency. Control centers may be trying to reach him with directive aid.

Third, a lack of knowledge of the terrain he was over resulted in the pilot landing at a point where the coastline was very steep and rugged. A short distance away, in either direction, were smooth beaches which would have materially increased the chances of getting safely ashore through the breakers.

To summarize, the station last in contact with a plane must spread the alarm more rapidly when a dangerous situation arises. In addition, it is highly desirable that pilots know the terrain over which they propose to fly and the importance of pre-flight briefing cannot be too strongly emphasized.

Wingwalk Covering

NAS, SEATTLE -- The Assembly and Repair Department has been experimenting with a new type of wingwalk covering and, while a somewhat similar type has been tried by the Army, it is believed to be a new scheme in the Navy and will perhaps be of interest to other naval air activities.

The material used is 3-M Trimate "Wetordry" abrasive cloth. The wing surface is first thoroughly cleaned, and a coat of cement, (Minnesota Mining EC-524) applied with a brush. The abrasive cloth is then bonded to the wing, after which a head is applied to the edge of the cloth, sealing the contact surface. (EC-498 Minnesota Mining).

This installation is believed to be impervious to oil, water and gasoline and the abrasive to be long wearing. Two hundred strokes of a wire brush on test panels prepared by the Minnesota Mining Company produced no appreciable wear.

These wingwalks have recently been installed on one SNJ-4. Although it is early to determine the durability of the wingwalks, the installation requires much less time than either the rubber mat type or the "sprinkled

on" abrasive type. Also the plane is ready for service immediately after the installation.

If the abrasive cloth proves to be all that the manufacturer claims, the method should be a marked improvement over the old style. Not only will the wingwalks be more durable, but also the plane will be out of service for a much shorter time during installation.

Designed from Scrap

NAS, MEMPHIS -- In these days of scarcity the lowly scrap pile has grown into one of the big "secret resources" of the war. As an example of what a little scrap and a lot of ingenuity can accomplish, the A & R at this Naval air station dug into a pile and came up with old hand presses, boiler plate,

and railroad car axles which they transformed into valuable ersatz tools and parts.

From the scrap boiler plate they developed an adjustable crankshaft run-out jig, which will accommodate any radio engine crankshaft, either with or without the main bearings. This unit simplifies the run-out check. A sketch is available for any base desiring one.

The hand press and railroad car axle were combined with more boiler plate to construct a fixture for disassembling and assembling master rod assemblies. Another piece of boiler was utilized with sections of 3-inch pipe and cold rolled bar stock to design a bearing puller. It will pull both rear and front main bearings and can also be used to replace

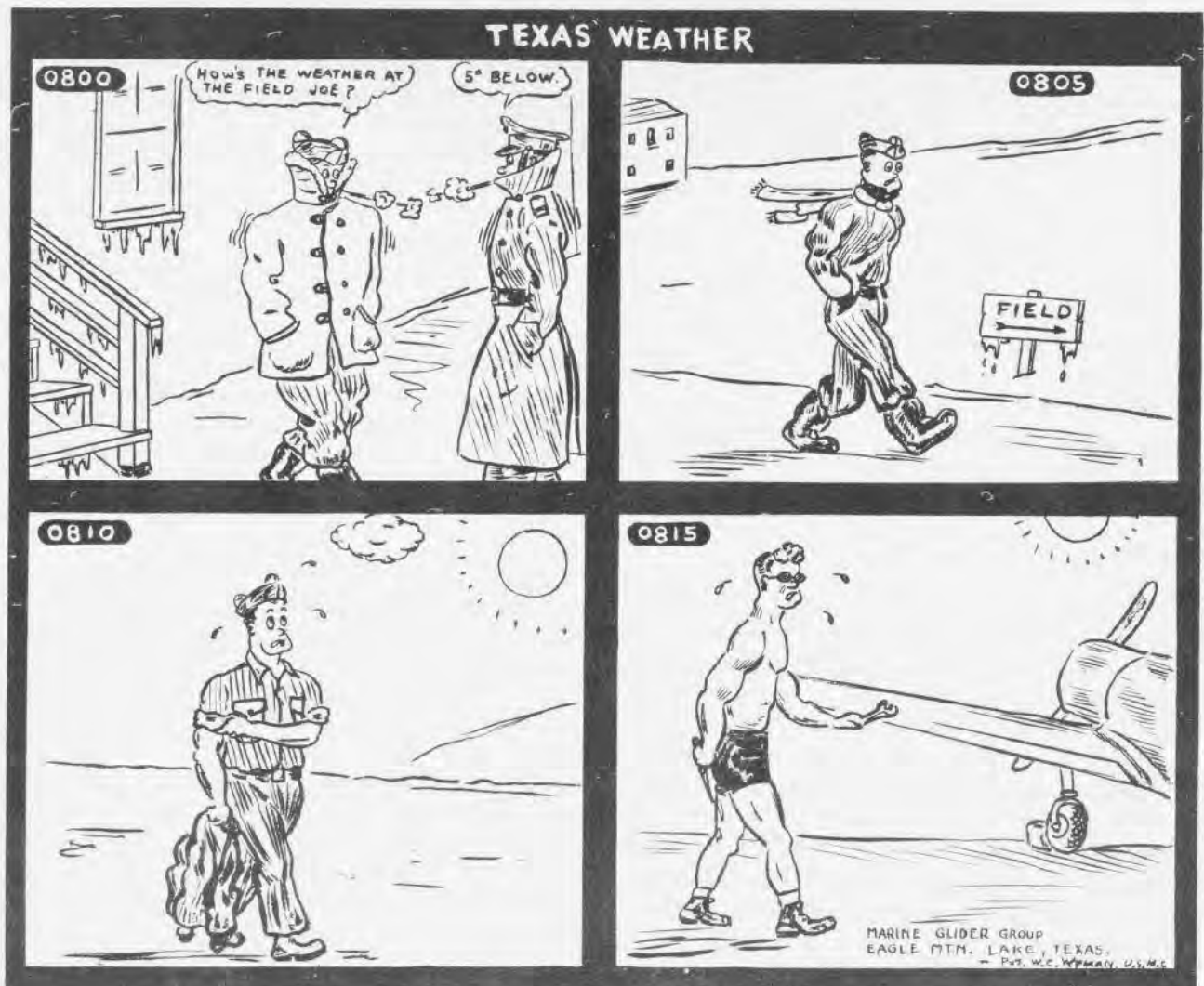

them. Sketches of this are also available.

From surveyed propeller hubs the A & R men made holding fixtures and timing discs. They worked out A Crankshaft Turn-Bolt wrench from a piece of old automotive steel.

Maybe the old scrap pile is your answer to the priority or production bugaboo.

Replacing Pre-Heat Gauges

Lt. B. V. Gates, USN, Engineering Officer of Squadron 2-A, Ellyson Field, Pensacola, has discovered a method of replacing pre-heat gauges in SNV-1 type training planes. Unable to obtain new gauges for the SNV-1, he found that the Free Air Temperature Gauge is a satisfactory substitute.

BUREAU COMMENT:-- The pre-heat gauges in SNV-1 airplanes are Army-furnished instruments for which no replacement Navy instruments specifically designed for the purpose are supplied. The replacement of failed pre-heat gauges is not required by the bureau since they are not considered essential to proper operation of the airplane engine. However, if a replacement is desired, the use of a free air temperature gauge (FSSC Nos. 88-I-2850 or 88-I-2865) is considered satisfactory; when this change is made it is also necessary to replace the Army bulb with a standard Navy bulb (FSSC No. 88-B-900).

Weather Problems

NAS, MINNEAPOLIS -- Heavy and frequent snows of the past two months combined with sleet and sub-zero weather have created a big problem for the snow crews of the Public Works Department. The men often worked all night so that ramp and runways of the station would be cleared for flight operations the following morning. Plows piled the snow in long banks four or five feet high. On the outlying fields, rollers and drags have been used to pack and roll the snow, thus keeping some of the fields in useable condition.

Self-Sealing Fuel Cells

NAS, ALAMEDA -- Several of the PBY-5 self-sealing fuel cells were recently damaged by the sharp edges of the channel stiffeners during the installation in the cells. In its modification Drawing No. 12293 which describes the rounding of the stiffener ends to prevent trouble, the station recommended that all units exercise caution during the installation and removal of self-sealing cells in the PBY-5's and -5A's and suggested that the stiffeners be modified.

New Job for A & R

NORMAN, OKLA. - Effective February 4, A & R was made responsible for performing the periodic checks and all maintenance work on the training aircraft of both squadrons. To provide the necessary power for this work the check and storeroom crews in both squadrons have been assigned to A & R, increasing the latter's personnel to 150 men. A small scale paratroop maneuver was executed February 1 by four riggers from the Parachute Loft who were anxious to give a practical demonstration of the reliability of their packing.

President Sees Transfer of Naval Aviation Funds

In a letter to the House requesting additional appropriations for the Navy, the President has asked that \$562,000,000 in 1942 Naval aviation appropriations be transferred and made available for expenditure in the 1943 fiscal year. The allotment brings the amount brought forward from the 1942 books for aviation up to \$1,630,000,000.

DON'T TALK



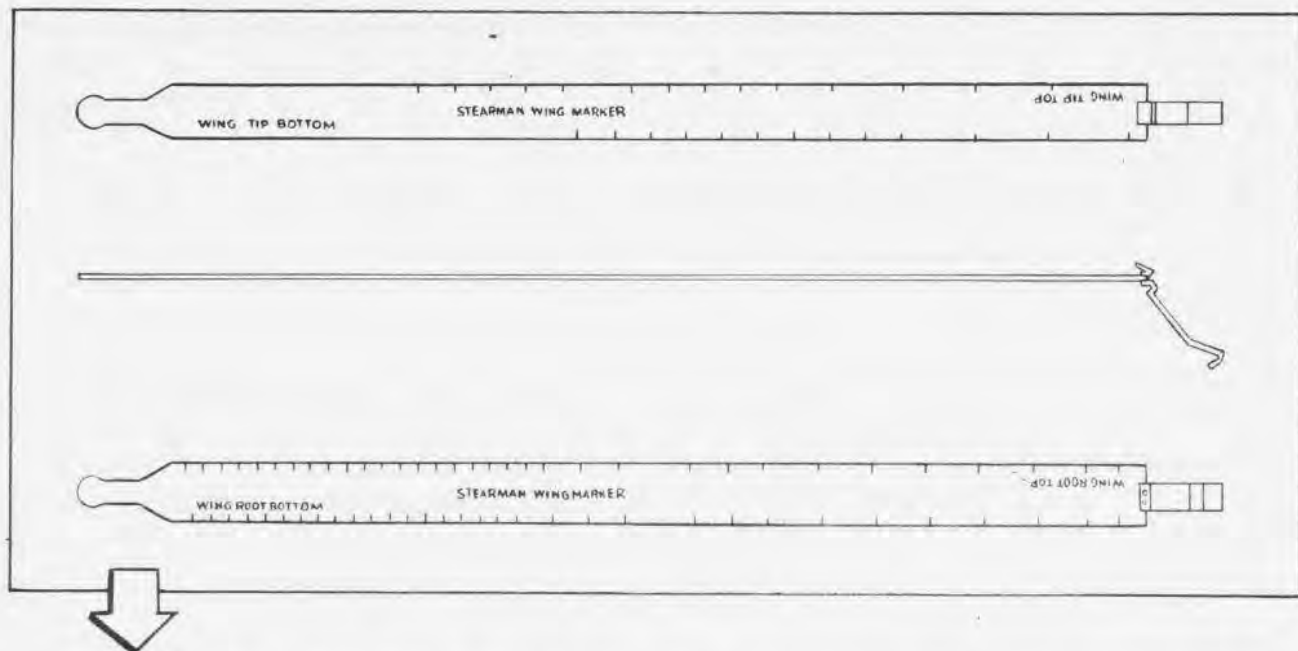

Stearman Wing Rib Stitch Marker

NAS, ST. LOUIS -- Ranking equally with the round wheel and the canopener, the yard stick and its numerous variations have played an important part as time savers. The A&R Shop at this activity has applied one of these variations to a new use designed to expedite marking of the positions for the rib stitches.

A special rule was made of a piece of flexible plywood, and a piece of stiff strap iron, as shown in the drawing. It is marked off, stenciled, and colored to show the proper scale for the particular stitches to be laid out.

From the one marker it is possible to locate properly the stitch positions on tops and bottoms of Stearman wings both at the root and the tip. It has meant a considerable time saving for the fabric shop over the old method of marking out stitch positions by scaling them off from an ordinary yard stick, and has insured that all stitches would go straight through the wing rather than at an angle.

Machine Shop

USMC, SAN DIEGO - Pilots of R4D's will be relieved of the work involved in figuring their relative magnetic

bearing with the manufacture of thirty azimuth set scales for the I-81A automatic direction finder indicators. These scales are to be mounted on the instrument panel at any 90° position. Part of the work on this job was the cutting of two gears which necessitated the manufacture of two cutters, one #6-40 pitch to cut 12 to 20 teeth, and one #1-40 pitch to cut 135 teeth.

OPERATIONS

The Operations Office has for some time been training men for duty in group operations offices. Due to the press of work and constantly changing personnel the course is being revised continually. In this school Men are trained in filing flight plans, instructions on Part 60 (CAA Air Regulations), reading of teletyped weather, interpretation of weather formulas, upkeep and care of plane, engine, propeller, daily and master log books, correction of sectional and regional airways maps through use of the Weekly Notice to Airmen, preparing charts for pilots and other matters which an operation clerk should know. Question and answer type letters between former students who are now stationed at various Marine Corps Air Stations and this office indicate that the course

is filling a need and possibly tending to standardize certain operations procedures.

Yankee Remedy Effective

NAS, BANANA RIVER - This southern station took a leaf from a Yankee book to stabilize drifting sand. The method used may prove helpful to other stations coping with a similar problem.

The Banana River Naval Air Station, situated on a small strip of land between the ocean and the river, was built entirely on dredged-in fill. This fill is composed of a fine white sand and shell with no clay content to act as a binder. A major problem was encountered to prevent this sand from drifting over streets, highways, and on the land field runways.

Approximately one year ago drifting sand blocked the main highway adjacent to the station and for twenty-four hours the highway was impassable. It was necessary to call out all contractor's equipment in addition to station equipment in order to clear the drifts and provide access to the station.

Grassing sanded areas is naturally the proven method to stop the drifting of sand. However, to get grass to grow in sand requires that a three inch top soil be cut into the sand and after the grass sprigs are set out constant watering is necessary for a period of about two months.

The area inside the perimeter of the four runways on this field amounts to approximately one million square yards and the enormous sum of money to cultivate it seemed exorbitant, not to mention the labor hours that could be used to better advantage in the war effort.

While striving to find some alternative measures, it was noticed that there was a great similarity to drifting snow and the thought occurred that the utilization of drift fences such as used in the north might serve the purpose. A test section of fence was installed and the results were promising.

With the windy season fast approaching, money was allocated by the Bureau to be used in this project. Fences were installed along all runways one hundred feet back from the edge, but although they served the purpose it was felt that something should be done in order that the fences could be removed.

In places along the highway where the sand does not drift a type of grass was found that grows wild and requires no watering or top soil. As this grass was just beginning to seed, it was cut and scattered over the sand and then harrowed in.

The sand fences are successfully stopping the sand from drifting over the runways, the station reports, and in spite of one of the driest seasons the grass is taking root and starting to stabilize the movement of the sand.

Runway Illumination

NAS, LOS ALAMITOS, CALIF. - Kerosene road flares, introduced on this station by Captain D. W. Tomlinson, have been made standard for runway illumination during night flying. Instructors report that the flares have made landings easier than with floodlights. Depth perception is better with flares and floodlight glare has been eliminated.

The first plywood N2T-1's arrived early in the month. They will make excellent trainers for the advanced stages, according to flight instructors who have checked out in them. Pilots report they handle nicely, have easy aileron action and a good rate of climb. Their flight characteristics are said to be similar to those of the later model Stearmans.

Can You Beat This?

BANANA RIVER, FLA. -- We have in this station four chief petty officers with a record of total service that would be hard to equal anywhere. These four, who are helping greatly in the training of the younger men, have -- 32, 34, 34, and 47 years' service, for a total of 147 years.

JAP



FACTS

Quality of Jap Fighter Pilots Described

The Japanese combat pilot is a mixture of sagacity and child-like gullibility, of cleverness and almost incredible carelessness, according to Major Rector of the Army Air Corps, who fought the Japanese as a fighter pilot in both the American Volunteer Group and the AAF. Major Rector has 12 combat victories.

He described a new Japanese 2-engined, 2-place fighter, the I-45, which began to make its combat appearance prior to his return to the U.S. This airplane is well armed, with a rear gunner in addition to the customary fixed forward guns. Despite its heavier armament, it is no match for the P-40 Warhawk, which can turn inside it, outfly, outclimb and outdive it. The Japanese have stripped some of these ships of all extra weight, including most of the guns, for reconnaissance purposes.

"Japanese guns and ammunition are definitely inferior to the American Ordnance, both in fire power and quality," Major Rector stated. "Their guns are low velocity types, lacking in range and penetration. The use of inferior materials is becoming apparent in the newer Japanese aircraft, resulting in reports that the flying time between overhauls has been reduced more than half for the Japanese planes."

Our Planes vs. Zeros

Jap fighter plane pilots are overconfident of their ability and the supposed superiority of the Zero over American aircraft, 1st Lieut. Lawrence M. Faulkner, U.S.M.C., said recently upon his return from the Solomon battle area. The records show that many

of them learn too late.

"The Jap Zero pilot is the 'bright boy' of enemy aviation," Lieut. Faulkner said. "They are cocky to a fault because they think their planes are more maneuverable than ours.

"What they fail to take into consideration is that a Wildcat will absorb twice as much punishment as a Zero and still be in the air when the enemy plane is in flames."

Lieut. Faulkner was one of "Colonel Bauer's boys" -- 23 Marine pilots who established the enviable record of downing some 80 enemy planes in the air over Guadalcanal, with the loss of only three pilots. They also destroyed ten beached enemy seaplanes on the island and were credited with sinking two enemy destroyers by strafing.

Flying a Grumman Wildcat fighter, Lieut. Faulkner was in action over Guadalcanal from October 16 until ordered back to the country for a well-deserved rest. He personally accounted for two enemy bombers and a fighter, and aided a fellow pilot in the strafing of one of the two destroyers credited to his squadron.

"We were glad," he said, "to have Wildcats when the enemy got on our tails.

"We would maneuver as best we could in our sturdier planes and wait until we got the Jap lined up and then send him down - often with a single burst from our guns."

He also exploded the theory that Jap pilots will not bail out of a burning plane.

"They will bail out of a Zero - and plenty fast - when she starts burning," he said. "I have not seen a pilot or the crew of an enemy bomber bail out, however. That may be because they do not have parachutes. We have never found a parachute in an enemy bomber that was shot down, to my knowledge."

Lieutenant Faulkner pointed out that knocking Zeros from the sky is a simple matter as compared to strafing surface vessels.

"The dive bomber pilots are the men who deserve a lot of credit. The ack-ack fire from enemy ships is fierce and it takes a lot of guts to dive into it loaded with bombs."

He added, however, that fighter planes are often able to aid the dive bombers by strafing the ship and drawing part of the antiaircraft fire. It was while strafing a destroyer in this manner that he and a fellow pilot "accidentally" sank the vessel.

Japanese Equipment

A careful going-over of captured Japanese equipment in Guadalcanal and New Guinea brought forth no big surprises to the Ordnance Bureau, but it revealed that they are a well-equipped bunch of fighting men for the job they have to do.

Many of their weapons were made in Germany or copied from French patterns. Their submachine gun is in reality an automatic pistol. It is lighter than the American small machine gun and is not as good; it carries a long bayonet, however. Their light gun is .256 caliber, like their heavier gun, has an attachment for converting it into an anti-aircraft rifle. The heavy gun, approximately .30 caliber, is effective up to 875 yards; it fires 500 rounds per minute from a strip that holds 30 rounds. It is gas actuated, and air cooled.

Other items, hardly effective against air attacks, include grenade dischargers, trench mortars, and the usual run of ground equipment. All material is described as "good", but not as good as ours.

Enemy Camouflage

I GERMAN

All German aircraft in active service appear to be camouflaged. The prevailing colors for bombers are green and very dark green on upper surfaces and pale blue on under surfaces. Fighters are colored a mottled gray-blue on the upper surfaces and a pale blue on the under surfaces.

German planes forced down in Allied territory or observed by Allied air crews were camouflaged as follows:

(1) A twin-engine night bomber had all under surfaces of the plane painted with a non-reflecting lamp-black paint. The only break was the German Air Force standard cross insignia painted in white.

(2) An Me-110, shot down in a night flight, had all under surfaces covered with lamp black, which could be easily rubbed off. It had apparently been applied as a temporary expedient when the airplane was diverted from day to night operations. Some night operational planes were painted all black, even recognition markings being obliterated.

(3) He-111's which attacked a convoy were camouflaged a dark green.

(4) Two He-113's were painted dark green on top and a very light gray under the fuselage, with yellow wing tips and nose. This camouflage blended extremely well with the sea.

(5) The German Air Force employs variations in camouflage to conform to local conditions. Their aircraft in Libya are reported as being light gray, and Me-109's have been over the Mediterranean painted with what is called "Sea Camouflage".

(6) British pilots claim that some Me-109's that were painted white underneath were invisible from 1,000 feet below.

(7) Some German planes in the Middle East are painted a dirty yellow on top and iron gray below; others, gray and brown mottled on the upper surfaces and duck-egg blue below.

(8) FW-190's which were forced down in England were camouflaged as follows:

(a) The top and sides were a mottled gray-blue, the under surface pale blue, and the rudder was yellow.

(b) The rudder and lower part of the engine cowling were painted yellow and the general camouflage was gray on the upper surfaces with duck-egg blue on lower surfaces.

(9) The camouflage of the Me-210 is the normal dark olive-green upper surface with duck-egg blue beneath. One-half of the spinners in dark green with the other half duck-egg blue, the colors blending with the general camouflage scheme.

(10) The following two aircraft were engaged in attacks on convoys, and no doubt their camouflage was adopted for this class of work:-

- (a) A Do-217 was mottled gray-green above and bright blue beneath.
- (b) A Ju-88 had a dark-colored upper surface and a light-green under surface

II JAPANESE

Camouflage of aircraft is practiced generally and apparently with good effect by the Japanese, and weather conditions and terrain receive prime consideration in their efforts to make their planes invisible.

The so-called "Aleutian" Zero plane, recovered by the U.S. Navy, was painted alike on all surfaces. The color, described as glossy greenish-gray, is difficult to see in the Aleutians' foggy atmospheric conditions.

Zeros were intercepted at Moresby which were completely white except for their national markings.

Two-engined bombers of bronze color have been sighted in the vicinity of northwest Australia. They were reported extremely difficult to see.

Japanese planes raiding the Solomon Islands were painted aluminum color. They carried no numerals, insignia, or Imperial colors on the wings, fuselage, or tail sections. When observed anywhere near the sun they were almost invisible.

Type-96 heavy bombers frequently have been camouflaged with irregular curling lines of light gray and light green.

Other Type-97 reconnaissance planes have been observed painted a dark gray.

Other Type Zero SSF's have been variously reported, as being painted "dark green, "brownish green, "shiny

jet black", "light brown", "orange", and "silver".

The Type- 97 fighter-bombers have been seen painted light gray.

Several float-type Zeros were engaged which were painted light blue with no conventional markings.

24-Hour Clock



Among the simple blessings that come with peace may be popular acceptance of the 24-hour clock. Aviation in particular will benefit by a change from the inconvenient A.M. and P.M. system, because "it is almost impossible to operate long-range international air schedules" on our present domestic method of telling time. The change cannot be made overnight, but millions of men now under arms are learning to live by the 24-point dial and will not have to be converted. European air and rail schedules and several American airlines now operate by the 24-hour clock.

24-Hour Bombing of Germany

The vital importance of round-the-clock bombing of Germany, with the AAF attacking by day and the RAF pounding by night, was stressed by Maj. Gen. Ira C. Eaker, Commanding General of the Eighth Air Force, in a statement issued by the War Dept.

"It is sometimes assumed that American Air Forces in Britain are wrong to bomb by day or the RAF in error to bomb by night. If the RAF bombed habitually by daytime its losses would be too high. If the U.S. Air Forces bombed at night its losses would be higher and its efficiency greatly

reduced. RAF bombers are built for night bombing and their crews have been specially trained to execute these missions. American bombers have been built for day bombardment and their crews specially trained in high altitude precision daylight bombing.

"This does not mean that the RAF cannot occasionally bomb by day, nor the AAF may not occasionally bomb at night. But neither would be in its best element."

REASONS

Three primary reasons were given by Gen. Eaker for maintaining the present day-and-night schedule. First, maximum destructive effort against the enemy can be realized only under these conditions. Second, enemy defenses must be alerted throughout the 24-hour period and it requires three shifts to do A.R.P. job and man the defenses adequately. This keeps several hundred thousand German workman from the factories and war industries. Third, American day bombers operating over Germany force the enemy to maintain a large force of day fighters which otherwise would be free to operate on Russian, African and other fronts.

BRITISH VS. AMERICAN

There is a malicious tendency in some quarters to compare British and American bombing aircraft, insisting that one is superior and the other inferior. The plain facts are that each is superlative for its particular type of work. The British 4-engined night bomber can carry a great load since it does not require defensive armament and a large crew. The American 4-engined bombers, the best day bombers in the world, must sacrifice bomb load to carry gunners, .50 caliber guns and thousands of rounds of ammunition. They make up for depreciated bomb load by their ability to hit small but vital targets.

5,489 Planes to United Nations

Donald Nelson's seventh monthly report to the nation on war production reveals that 5,489 aircraft were de-

livered to the Army, Navy, and other United Nations in December. Using the WPB's computations, this represents an increase of 20% over November

Flying Boat or Land Plane?

The long-standing controversy over whether the flying boat or the land plane is better for transporting cargo is analyzed in the March issue of Flying, by Theodore P. Hall, chief production engineer of Consolidated Aircraft Corporation. Matters safety, practicability, and operational costs are considered. Building costs according to Mr. Hall, are approximately the same.

"Methods of construction are just about the same, save for the difference in landing gear and hull," Mr. Hall writes. "Weight comparison of the flying boat and the military land plane capable of the same range shows the boat about 20% heavier than the land plane.

"The larger hull of the flying boat results in slower speed than that of the comparable military plane. As to operation, because the boat is slower it will make fewer trips over a scheduled route. It will require more gasoline to propel it. This means a greater cost to the operator using the flying boat."

On the other hand, it was pointed out, the flying boat has many advantages over the heavy land based plane in matter of landing, especially in wild country where lakes and rivers are plentiful and expensively constructed air fields are scarce. Even in rough water, once the boats are down, they will ride a heavy sea.

"Operational circumstances govern the choice of land planes or flying boats," concludes Mr. Hall. "There is little use in comparing the planes as planes, but only in relation to the jobs they are going to be called on to do.

"In a task where high speed is essential, and where suitable landing fields are available, I think it is safe to favor the land plane. On the

other hand, when very high speed is not essential, and where there are no suitable airports, I think the flying boat can do the better job."



Who's Got Snow?

The flight angle of this story is simply that it is about people who fly all over the world and write stories about people in the armed forces who fly all over the world. The rest of the story has to do with censorship, and a security officer in far off Alaska who even now is not certain whether Maxine Davis is a woman journalist or a Japanese spy.

Miss Davis recently returned from Alaska with an article for the Saturday Evening Post and a personal experience that is just beginning to seem amusing to her.

With credentials and an accredited correspondent's rating all properly checked by the Navy and Army officials, Miss Davis started an air tour of Alaska. At Dutch Harbor she had her first encounter with scuttlebut. It was about another Saturday Evening Post article writer named Edgar Snow. The scuttlebut was that Ed Snow had been in Nome the week before, that he was flying to Attu, and generally he was going to clean up Alaska, journalistically, for the Post.

Miss Davis was indignant. She wanted to know why the Post was sending another writer to trail her around. She cabled her New York agent:

"WHY IS SNOW IN ALASKA?"

The Dutch Harbor censor sent for the security officer, and the security officer got busy. "Trying to send out code messages, are you?" he demanded of Miss Davis. "There's a war going on, and you know the rules."

Miss Davis tried to explain, but the security officer would have none of her explanations. Then Miss Davis stuck her chin forward and announced that, war or no war, the cable was going through, which broadened the breach. For two days the wrangle continued. Then for no reason at all, someone high in authority who knew that Ed Snow was a Post writer, smoothed it over. Miss Davis sent the cable, and went about her work. Meantime, however, the security officer was re-checking her credentials and letting it be pretty well understood that he, personally, didn't believe any part of the Ed Snow explanation to this code cable.

Miss Davis finished her work, and was on the verge of shoving off, when a reply to the cable came from New York. It brazenly stated:

"SNOW IN INDIA."

It was the business all over again.

"You not only send out code messages," he accused but you *get* code messages. Right over a government station! 'Why is snow in Alaska? -- Snow in India'. It's hard enough living up here in this climate, away from my family, without having to put

up with double-talk cablegrams, right under my nose. It's too much. I don't care who says what about you, you're not going to get away with this."

Another two days of re-checking credentials, pulling wires and getting instructions from higher authority, and Miss Davis was permitted to fly home with her article. But the security officer doesn't believe any part of it, and he doesn't think it is funny.

German Devices for Assisting the Take-off of Overloaded Planes

In order to increase the loads and ranges of their bombers and observation planes, the German Air Force has resorted to overloading. Once in the air, planes can fly with considerable overload, although their speed is somewhat reduced; the main operational difficulty lies in the take-off. A normal take-off under overloaded conditions will require a runway of abnormal length; this is generally impracticable. The Germans have devised other means which have proven so successful that even smaller fields than heretofore are now being used.

There are three main types of assisted take-off: the catapult, the winch, and the rocket system.

a. The catapult is not mobile, but aside from this it has proven itself adaptable for ground operations.

b. The winch system was adopted by the German Air Force in 1940 to assist overloaded Heinkel HE-111 bombers in taking off from small airports. It now appears to be standard. This equipment is believed to consist of a large drum-pulley coupled by a clutch to a fly-wheel which is driven through gears by a powerful aero-engine. The entire device is mounted on wheels and can be moved to the required location by a tractor. A cable approximately 825 feet long is wound over the pulley and attached by a hook to a shackle underneath the fuselage. The tail of

the plane is fastened by an electromagnetic coupling to a smaller winch.

The aircraft, after being placed in approximate take-off position, is pulled backward by the smaller winch until the main cable is taut; the plane is thus held in starting position for the take-off. After running up his engines to full throttle, the pilot presses a switch which simultaneously drops the tail coupling and engages the clutch in the main winch. The aircraft is pulled forward at a high speed and, as it rises and flies over the winch, the main cable is disengaged by its own weight. The clutch is thereupon automatically disengaged and a brake applied to the winding drum. Attachments found on planes such as the Dornier-17 lead to the belief that devices of this or similar types are probably in general use.

c. The cheapest and most convenient form of assisted take-off is probably the rocket device now in use by the German Air Force on the Ju-88, the Me-110, and other aircraft. It usually consists of two large pear-shaped rockets attached by special fittings to the underside of each wing. These rockets may have a venturi-type discharge nozzle and are believed to be activated by slow-burning cordite or some other fuel and compressed air. If cordite, the powder may be in sections which are progressively ignited.

After a short take-off run the pilot presses an electrical switch, igniting the rockets. Should the need arise, he may extinguish them almost instantaneously by turning off the switch. The thrust of these rockets lasts about 30 seconds. When the aircraft has risen about 500 feet, the rocket gear, which is quite large and heavy, is jettisoned and drops to the ground by parachute. It is believed that the rockets can be loaded and used again.

While aircraft must be specially equipped to use this device, the apparent simplicity of the rocket method will no doubt increase its use for

planes operating from restricted fields under conditions of overload.

New Program for Randolph Field

Randolph Field, Texas, will cease to train aviation cadets in March when it will be converted into a new type of flying school for the training of flying instructors for the Army Air Forces.

Under the new program for Randolph Field, picked commissioned flying officers of the Army Air Forces will be given special instruction in the most advanced methods of flying training. Students will be selected from graduating classes of the AAF advanced flying training schools. The length

of the course will vary from 1 to 2 months. The new school will begin operation when the present class of aviation cadets at Randolph Field is graduated.

Schools similar to the one being established at Randolph Field are already in operation for instructors in bombardier training and aerial gunnery at Carlshed, New Mexico, and Fort Meyers, Florida, respectively.

Graduates of the new school at Randolph Field, which will be known as the Army Air Forces Central Instructors' School, will be assigned as instructors in the various flying training schools of the AAF throughout the U.S. to replace instructors who will be made available for combat duty.



Deluxe Life Buoys

A series of deluxe life buoys to provide haven for shot down Nazi fliers have been spotted in the English channel. The buoys were designed by the German Ministry of Navigation, and are being anchored in well charted spots in the channel.

A description of the floats indicates they are designed both for easy spotting and for comfort of distressed Nazi pilots. The buoy is of hexagonal construction and has floor space of about 43 square feet. On the upper deck of the cabin is an oval turret six feet high which carries a signal mast and radio antenna. The buoys are anchored with a long cable so the drift indicates the swing of the current. They are painted bright yellow above the waterline and red crosses are shown against white ovals on the turret.

Each buoy can accommodate four persons in comfort for several days, and in an emergency the crews of several planes can be housed. Food, dry clothing and cigarettes are stored inside. Light and heat are provided by storage batteries, with kerosene stoves and lamps as auxiliary. Games, stationery and playing cards are provided for entertainment of stranded crews until rescue is effected. Depleted supplies are immediately replaced by the rescue ship.

Army's Conservation of Crude Rubber

The Army's rubber conservation program has reduced the use of crude rubber in war material by 45% on the basis of the amount of rubber in the same material as of Dec. 7, 1941, the War Dept. announces.

Pedal pads and mats in trucks have been eliminated, airplane vibration pads have been made round instead of square, reducing the volume without impairing the function; polyvinyl rasins have replaced rubber for insulation on cable and other electric wire; new tire compounds have been perfected for Ordnance Motor Transport vehicles; butyl is replacing natural

rubber for floats, boats, rafts, and other inflatable items; Buna S is replacing natural rubber in tires, tire mileage quality has been adjusted to the life expectancy of vehicles; field artillery and antiaircraft guns, and ceilings have been placed on the rubber content of all Ordnance Motor Transport tires by sizes.



German Snare?

New markings on German planes in the Mediterranean have been noticed by British fighters at Malta. The mark now is a slim black cross on a white background, surrounded by a black circle.

"This apparently is intended," the notice states, "to fool our antiaircraft guns into thinking they are Italians or friendly roundels, and catch us off guard."

Mitchell Bombers for Navy

North American Aviation's B-25 Mitchell bombers, which have been in action on ten major fronts during the last 12 months, will also be used by the U. S. Navy. The Navy bomber has been designated the PBJ-1 Mitchell.

The B-25's, brought to fame by Brig. Gen. James H. Doolittle's attack on Tokyo, also have been employed by the U. S. Army Air Forces against the Axis in the Philippines, New Guinea, Russia, North Africa, Tunisia, occupied Europe, China, and the Aleutians.

In addition, the Mitchells are employed in the air forces of the Netherlands East Indies, Russia, China, and Great Britain.

25 years ago this month

The early records of U.S. Naval Aviation are sketchy and incomplete. This is easy to understand once it is realized that the Bureau of Aeronautics did not come into being until 1921.

The following are excerpts from a chronology of Naval Aviation that was drawn up after exhaustive research. To the new generation lacking a knowledge of that period, the entries will seem fragmentary. Oldtimers may draw a nostalgic breath.

Naval Aviation 1915-

Mar. First contingent of naval aviation consisting of 35 officers and 300 men arrive at Lake Balsaena. Planes used were Italian FBA'S, L-3's and Macchi 8's and for the chase, the Macchi 5's.

Mar. Captain C.R. Train, Naval Attache to Rome, assisted by Lt. Com. J.L. Callan, in charge of U.S. Naval Aviation in Italy.



Captain N. E. Irwin, who became the first Director of Naval Aviation, March 7, 1918

The First Aviation Squadron (Marines) transferred from Lake Charles to the Marine Flying Field, Miami, Florida. Here four squadrons were

formed to act as a Day-Wing under the Navy of the Northern Bombing Group. Mar. 7. General Order No. 375 creates the Office of the Director of Naval Aviation, directly responsible to Chief of Naval Operation.

Mar. 10. LTA base begun at Guipavas. Commanding Officer Lt. J. F. Maloney, U.S.N.

Mar. 15. LTA Base begun at Arcachon. Commanding Officer, Lt. Zeno Vicks, U.S.N. 14 HS-1 boats delivered and pilots being assembled, but operations did not begin until about the first of November, 1918.

Mar. 18-19. Suggestion by Ensign Nugent Fullon, USNR:

DH-4 Type of fast fighting and bombing land machines be added to the above fleet. A fleet of eight or more of them launched from suitable platforms on ships and equipped with air bags to float them in case of need, backed by, say, three seaplanes, could conduct operation at great distances from their bases, do material damage, and should be able to meet enemy tact. Their chances of being lost in action are much less than those of the seaplane. Their chance of being lost at sea are certainly no greater. The handling of the land machines aboard the ship is simple and economical. The possibilities of making them floatable for a period of 18 hours, without any considerable weight or obstruction, is great. The whole problem offers a wonderful field for study and improvement."

Security Black Out

In an effort to keep the RAF on its toes at all times, the current Royal Airforce Journal has an editorial entitled "Security Blackout."

"You watch a batsman playing with enormous concentration on a difficult wicket, and then, just as his hundred seems in the bag, he gets bowled neck and crop by a slow half-volley. It may be that he has thought about his lunch or caught a glimpse of a snappy blonde over cover-point's shoulder. Anyway, there it is. Concentration goes for a moment, and he's finished."

Applicable, what?

TECHNICALLY SPEAKING

Electrical Connectors

Some reports are being received of electrical connectors separating due to vibration. Attention is invited to BuAer letter Aer-E-31250-LB, F36-2(7), Serial 176077, dated 11 December, 1942, which directs safety wiring, clamping, taping, or otherwise securing these connectors against separation, when installed ahead of the firewall. Activities concerned are urged to completely incorporate all these precautionary measures as soon as possible.

In the case of connectors installed on generators, particularly, the magnitude of current carried makes it essential that the connectors not be allowed to separate, as any increase in contact resistance may overheat the connector and cause severe damage prior to final separation.



Taxiway Lights



A unit that provides taxiway lights for night flying operations at points where it was inconvenient to run power lines, has been assembled by Carrier Aircraft Service Unit Two of the Air Force, Pacific Fleet.

The unit is composed of material readily available to aircraft units and squadrons. One inch strap, one-quarter inch rod, one S-17 storage battery, an aircraft type light receptacle, and a snap switch are the essential materials used.

Units of this type have successfully replaced traffic directors at points along the route of planes back to the operating line. They have also served as obstruction lights.

The advantages of the unit compared to a flashlight or portable electric lamp are:

- (a) It can be seen from all directions.
- (b) It does not illuminate excessively.
- (c) It does not throw a beam.
- (d) The small current drain of a 3 C.P. bulb permits the battery to be used more than 40 hours without recharging.

New Raft Signalling Lights

"An experimental quantity of life raft and life jacket signalling lights in accordance with Navy Aeronautical Specification M-567 have been procured and are being delivered in these quantities:

NAS Pearl Harbor	- 3000
NAS San Diego	- 3000
NAS Norfolk	- 2000
NAS Seattle	- 1000
NAS Quonset Point	- 1000

Activities should requisition the lights from these points if their use is considered desirable.

These lights are for use in attracting the attention of rescuers to personnel forced down at sea. They are also provided with a keying button for signalling in Morse code. The pictures show the construction and means of attachment provided with the light.

The bureau will appreciate receiving comments on the effectiveness of these lights for rescue purposes as well as opinion as to whether this item should be considered a part of the life raft emergency equipment.



Clamp by which light is attached to life jacket also bears instructions

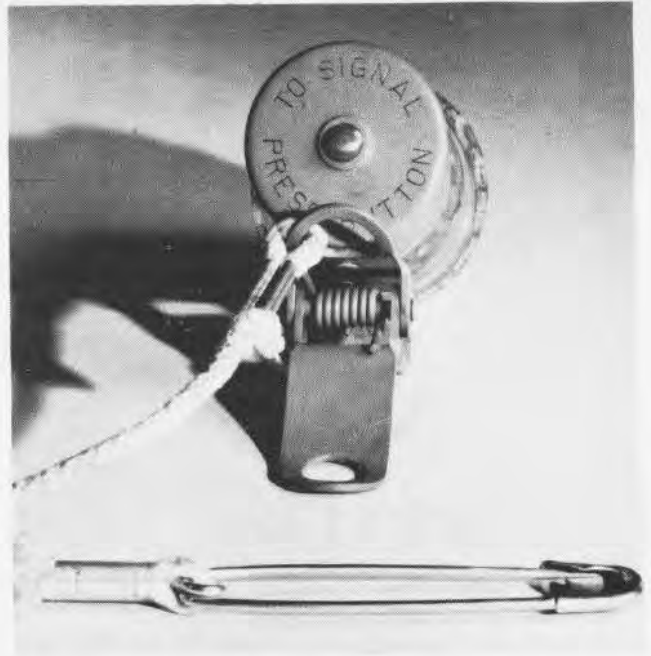

End view indicates the position of the signal button on the light



Full view shows complete equipment with instructions for operating

ARMY LIFE RAFT



This "Flying Fortress" raft designed at Wright Field carries seven men and has a sail to navigate with winds.

Tarpaulin is part of raft equipment to protect men against sun.



Following the lead of the Navy, Army Flying Fortresses are now being equipped with life rafts with a mast and sail. The development was the result of Captain Eddie Rickenbacker's unhappy experience of being lost at sea when his plane went down in the Pacific.

The new arrangement of mast and sail was devised at the Equipment Laboratory of the Army Air Force's Material Center, at Wright Field. Captain William Cherry, Rickenbacker's pilot on the ill-fated Pacific flight, was consultant. The sail design is described in the current issue of *Southern Flight* as "A square rigged sail which enables seven men to navigate in the wind." Any Navy man, looking at the photograph of the sailing raft, can tell at a glance that it is a bastard lugs'r rigged to a jurmast and won't point within 160 degrees of the wind.

Navy life rafts have been equipped for sailing for nearly a year.

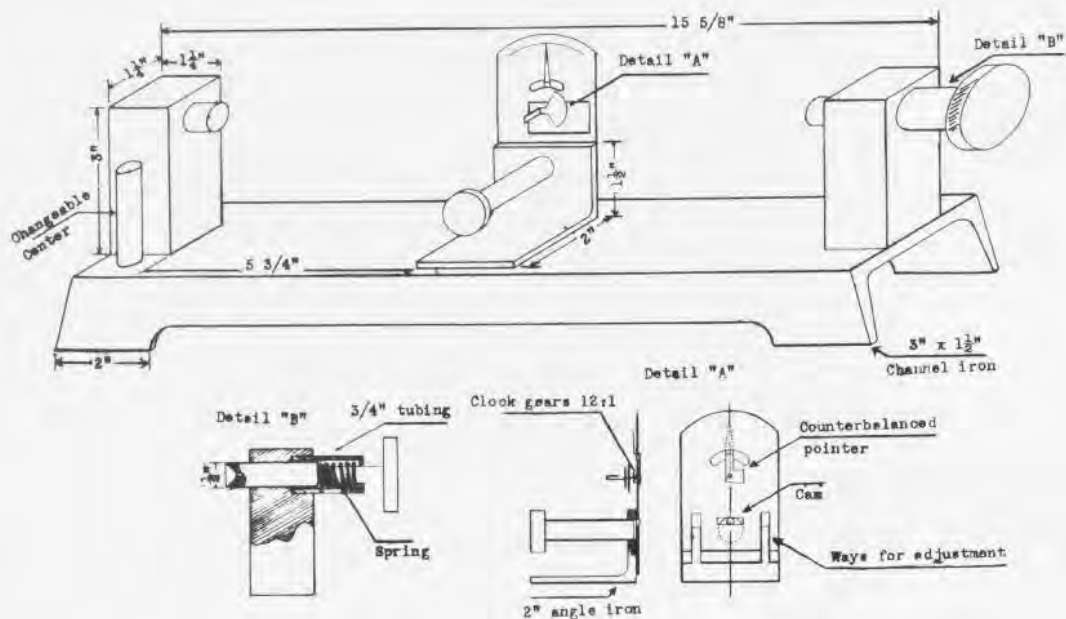

PUSH ROD TESTER

N.A.S., Minneapolis -- Due to the tapered design and enlarged mid-section of the Lycoming R-680-8 Push Rod, a suitable jig for checking bent rods has been developed by W.R. Rasmussen, AMM1c. (See illus.) The push rod is suspended by placing the ball ends between inverted cones and revolving manually with the fingers.

As the spherical ends constitute the working axis, any eccentricity due to bending or manufacture will be noticed on the indicator. An indicator is mounted on the fixture. This consists of two aircraft clock gears and a balanced follower and pointer. A cam action raises and lowers the indicator to compensate for the difference be-

tween the two rod diameters and to center the pointer for easier reading. The scale is graduated into .060". This gives an ample reading range and magnified detection for ascertaining the condition of the rod.

The frame is made of 1 1/2" x 3" channel iron, with 3" x 1 1/4" post on each end, in which the cones are mounted. One cone is under spring tension for grasping the rod and other cone is interchangeable for both the Lycoming R-680-8 and the Continental R-670-4 Rods.

BUREAU COMMENT:

Looks like a good set up for determining if push rods are slightly bent.

(Suggestion from NAS)

TOW BAR



After all hands and the ship's cook had been broken out a few times to push PV-1 airplanes around the squadron area, it was decided that necessity must mother another invention. A tow bar, shown in picture, was designed and built by J. C. McAuliffe, AM1c. This bar has a device which engages the through belt in the PV-1 axle. The bar permits towing this heavy plane with safety and accurate control and the squadron is very proud of the towing bar and its designer. Its merits have been proven to such an extent that every activity on the air station having PV-1 airplanes has borrowed or copied the towing bar. Any unit desiring the plans for the bar may communicate with this squadron (VS-2D12, c/o Fleet P.O., San Francisco).

BUREAU COMMENT : The improvised tow bar is undoubtedly doing a good job for VS-2-D12, and its designer is to be complimented. While the bar is useful for the PV-1 type plane it has however, two disadvantages: (1) The bar is not cross-braced, hence when the towing tractor makes a sharp turn it will tend to buckle or bend the bar on the side in which the tractor is turning. (2) It cannot be used on other types of planes. It is worthy of note, in this connection, that the Bureau has developed and is processing a universal tow bar Model NA-2143 with a cross brace that can be used on PV-1, SBD's, TBF's, SB2C's, F4U's, and F4F's. It will be a useful piece of airplane handling equipment and will be generally more practical.

NOTICE

Bulletins & Changes * Technical Notes & Orders

LIST OF THE LATEST NUMBERS
OF ENGINE BULLETINS AND CHANGES
(Succeeds list dated 26 January 1943)

25 February 1943

ENGINE	PRATT & WHITNEY BULLETIN CHANGE	WRIGHT BULLETIN CHANGE	DATE
R- 985	95		12-22-43
R-1830	301		Being issued
R-1830	302		Being issued
R-1830	303		Being issued
R-1830	304		Being issued
R-1830	305		Being issued
R-1830	306		Being issued
R-1830	307		Being issued
R-2000	19		Being issued
R-2000	20		Being issued
R-2000	21		Being issued
R-2000	22		Being issued
R-2000	23		Being issued
R-2000	24		Being issued
R-2000	25		Being issued
R-2800	37		2-8-43
R-2800	45		2-8-43
R-2800	46		2-8-43
R-2800	47		Being issued
R-2800	48		2-8-43
R-2800	49		Being issued
R-2800	50		Being issued
R-2800	51		Being issued
R-2800	52		Being issued
R-2800	53		Being issued
R-2800	54		Being issued
R-2800	55		Being issued
R-1830-90			Being issued

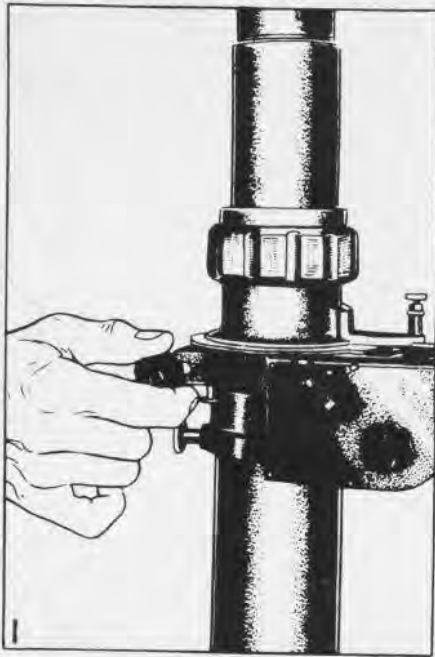

Mark 6 and 7 Drift Sights

Mark 6 drift sights are not considered to be of sufficient value to warrant the increased weight of their installation in combat airplanes and they will continue to be installed hereafter only in Model RB-1 airplanes.

For similar reasons, Mark 7 drift sights, heretofore installed in most VPB airplanes, will in the future be installed in only the following airplanes: Models PBY-5, PBY-5A, PBN-1, PB2B-1, and PBV-1. They have been retained in the airplanes noted only in the interests of standardization with similar models furnished to the British.

In the case of either drift sight, if the airplane concerned already has provision for its installation, a suitable instrument may be drawn from stock and installed at the discretion of the Commanding Officer of the activity concerned. If an instrument of either type is already installed and it is not in use, it may be removed and returned to stock at the discretion of the Commanding Officer.

The policy outlined in the foregoing paragraphs has been established as the result of adverse comments from the service regarding the serviceability of the two types of sights.

Improper Ground Handling

Reports of Unsatisfactory or Defective Materials of airplane structural failures have been received which are considered to be the result of improper ground handling. It is not considered desirable to increase the weight of airplanes by providing excess strength in parts which are considered amply strong to meet operational requirements.

Personnel should be cautioned against the following:

1. Walking upon surfaces where "Step" areas are not provided.
2. Lifting the tails of airplanes by placing their shoulders under the tail surfaces.
3. Pushing or pulling the airplane at tail surfaces, trailing edge of wing, or external brace wires.
4. Neglecting to secure control surfaces to prevent buffeting when airplane is parked.
5. Using the counterbalances on the landing gear on Model F4F airplanes for steps, for pushing the airplane, or as a support while working in the accessory section of these airplanes.

Requests for Recognition Equipment

It has come to the attention of the Bureau that various activities are addressing requests for Recognition equipment and/or Recognition instructors variously to NTS (Recognition), Columbus, Ohio, the Bureau of Aeronautics Liaison Officer at Columbus, Ohio; Ohio State University, and, in some instances, to civilians at the University where NTS (Recognition) is located. It is requested that this irregular procedure be discontinued and that all such requests be directed in official form to the Chief of the Bureau, where they will receive the earliest possible attention.

DON'T TALK



AIR WARFARE DIARY

Feb. 15- During the morning, a force of Marauders, with Airacobra and Warhawk escort, bombed Jap positions and started fires on Kolombangara Island, 190 nautical miles northwest of Guadalcanal airfield.

Later in the morning, and again in the afternoon, Dauntless and Avengers, with Wildcat escort, carried out two attacks on enemy positions at Munda. None of our planes were lost during these missions although some damage was suffered as a result of enemy anti-aircraft fire.

During the evening, three of our planes were dispatched to attack Jap positions in the Shortland Island area. One of the planes dropped bombs on Ballale Island. One of our planes failed to return.

Still later, a Liberator, with escort, attacked the Jap airfield at Kahili. One of the escorting planes failed to return.



Feb. 17- Fires were started in the Jap-held area at Munda as the result of Dauntless bombings with fighter escort.

During the night of Feb. 17th and 18th, our aircraft bombed enemy positions on Kolombangara Island.

U. S. aircraft shot down two Jap float planes which attempted to attack our positions in the western



Aleutians. No damage resulted.

Feb. 19- Our planes bombed Jap positions at Vila, on the southern coast of Kolombangara Island and at Munda. Large fires were started and hits were scored on anti-aircraft installations. One of our planes failed to return from these attack missions.

Feb. 21- During the morning, Jap planes carried out a light raid on our positions on Espiritu Santo Island in the New Hebrides. During the afternoon, Avengers and Dauntless, with fighter escort, attacked Jap positions at Munda. Several fires were started in the target areas.

During the night of Feb. 21st and 22nd, Jap planes raided our positions at Tulagi in the Nggela Group of the Solomon Islands.

Avengers and Dauntless, with Warhawk and Corsair escort, bombed Jap positions at Munda. Fires were started in the target area. One U. S. fighter failed to return.

Feb. 22- During the morning Liberators and Mitchells, with Lightning escort, bombed Jap positions at Kiska. All our planes returned. At Vila and Munda, Liberators attacked Jap positions. Results of the bombing at Vila were not observed but fires were started in the Munda area. All our planes returned.

One of our search planes, operating near Choiseul Island, scored bomb hits on an enemy barge loaded

with Jap soldiers. During the late afternoon, Airacobras, Corsairs and Lightnings strafed enemy positions at Rekata Bay.

Feb.23- During the early morning, an enemy plane dropped bombs on the airfield at Guadalcanal.



Feb.23- During the nights of Feb. 23rd and & 24 24th, Liberators bombed enemy positions at Vila and at Munda. All our planes returned. In the north Pacific, U. S. bombers, with fighter escort, attacked Jap positions at Kiska. Clouds prevented observation of results.

Feb.25- A second bombing raid was made by us on the Kiska area. Shifting to the south Pacific, a force of Dauntless, with Lightning and Wildcat escort, bombed Jap positions at Vila. Fires were started in the target area.

Liberators attacked enemy positions at Kahili and at Faisi in the Shortland Island area.

Feb.26- Dauntless, with Wildcat escort, accounted for many fires and the destruction of at least one plane on the ground, when the eggs were laid on Jap positions at Munda.

Feb.27- Munda was again the scene of an afternoon attack by our bombers with fighter escort. One large and two small fires were started. All our planes returned.

Another afternoon attack was launched by the same type planes, This time a Jap transport, with an escort of two corvettes, was the victim. Several bomb hits were scored on the transport which was left burning. One of the corvettes was hit and left burning and one float-type Zero was shot down. Two of our fighters failed to return. In the north Pacific, a force of

heavy and medium bombers, with fighter escort, attacked Jap positions at Kiska. Results were not observed. All our planes returned. Feb.28- During the afternoon, enemy positions at Kiska were again attacked by U. S. medium bombers. Hits were observed in the camp area. All our planes returned.

A Hudson patrol bomber dropped its load in the area of Munda.

A force of Liberators and Avengers attacked Jap shipping off Buin and bombed enemy airfields at Kahili and Ballale in the Shortland Island area. An enemy cargo ship was hit, blew up and sank. Large fires were started on the islands and an enemy plane was destroyed on the ground. One of our planes failed to return.

All our planes returned from a bombing mission on enemy positions at Kiska. Hits were observed in the camp area.



Mar.1- Fires were started in the Jap-held area at Munda by a force of Dauntless with Wildcat escort. All our planes returned.

Mar.2- A Hudson, returning from a mission, dropped bombs on Jap positions at Munda.

Mar.3- Liberators dropped bombs in the enemy-held areas at Kahili, Buin, Ballale and Vila in the northwestern Solomons.

Dauntless, with Wildcat escort, attacked enemy positions and started a fire at Munda. All our planes returned from this day's mission.

CLOSING DATES

for next issues of **NEWS LETTER**

MAR. 20th for APR. 1st issue

APR. 4th for APR. 15th issue

Illustrations, including photographs and drawings, should be sent with copy when they improve or contribute to better understanding of text.